

SSK006_e_

Movano Outrigger fitting kit.

FITTING INSTRUCTIONS

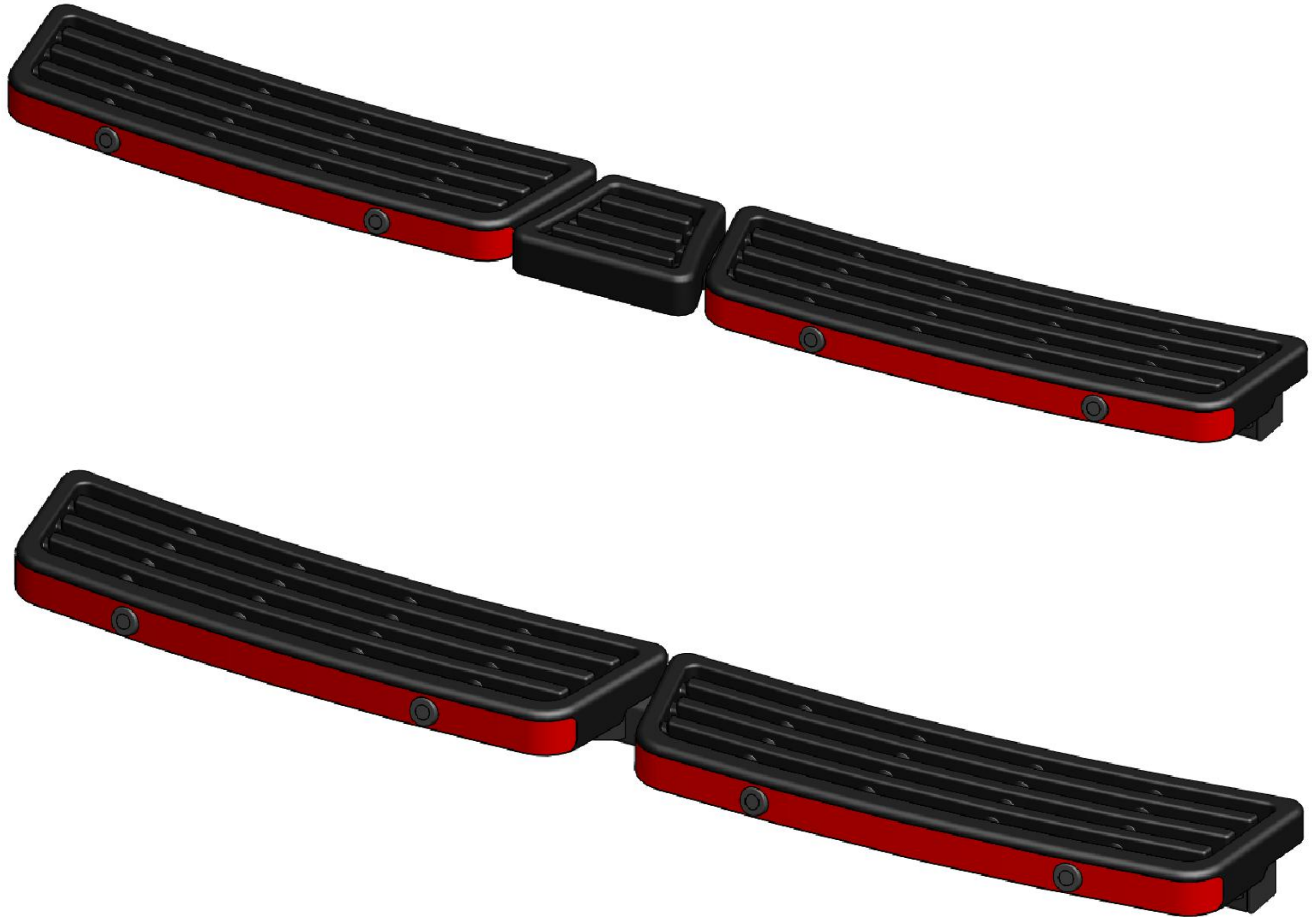

FITTING INSTRUCTIONS

FITTING KIT CONTENTS FK888
(1:1)



FW020 (M8) x 4

ACCESSSTEP	✗
IMPACT STEP	✓

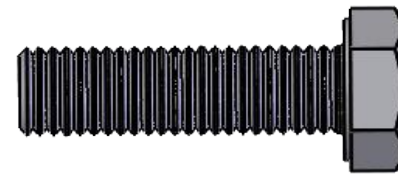

FB006 (M8) x 4

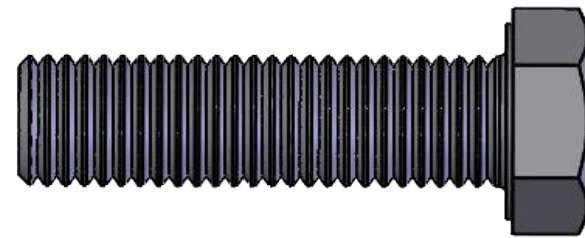

FS082 (M12) x 6

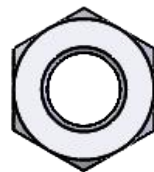

FN006 (M8) x 4

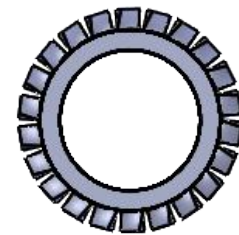

FW029 (M12) x 6

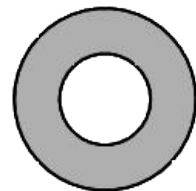

FW021 (M8) x 8

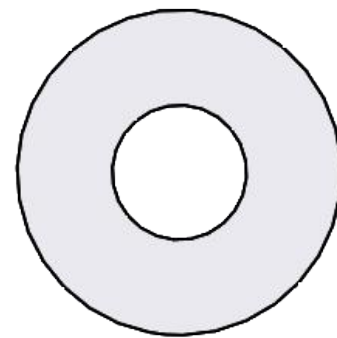

FW026 (M12) x 6

FITTING TIME: 30 Minutes

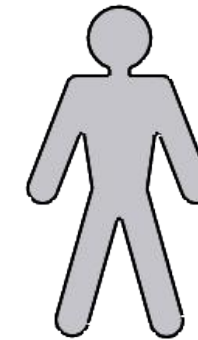
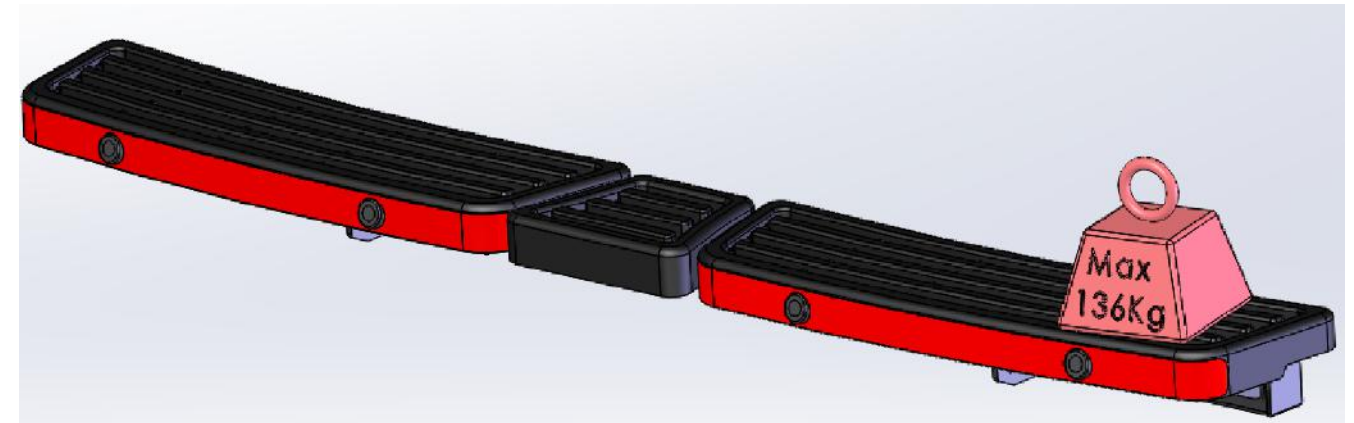

x 1



19mm x 1

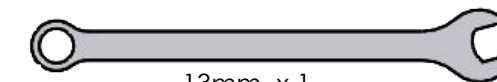

13mm x 1

13mm x 1

FITTING INSTRUCTIONS

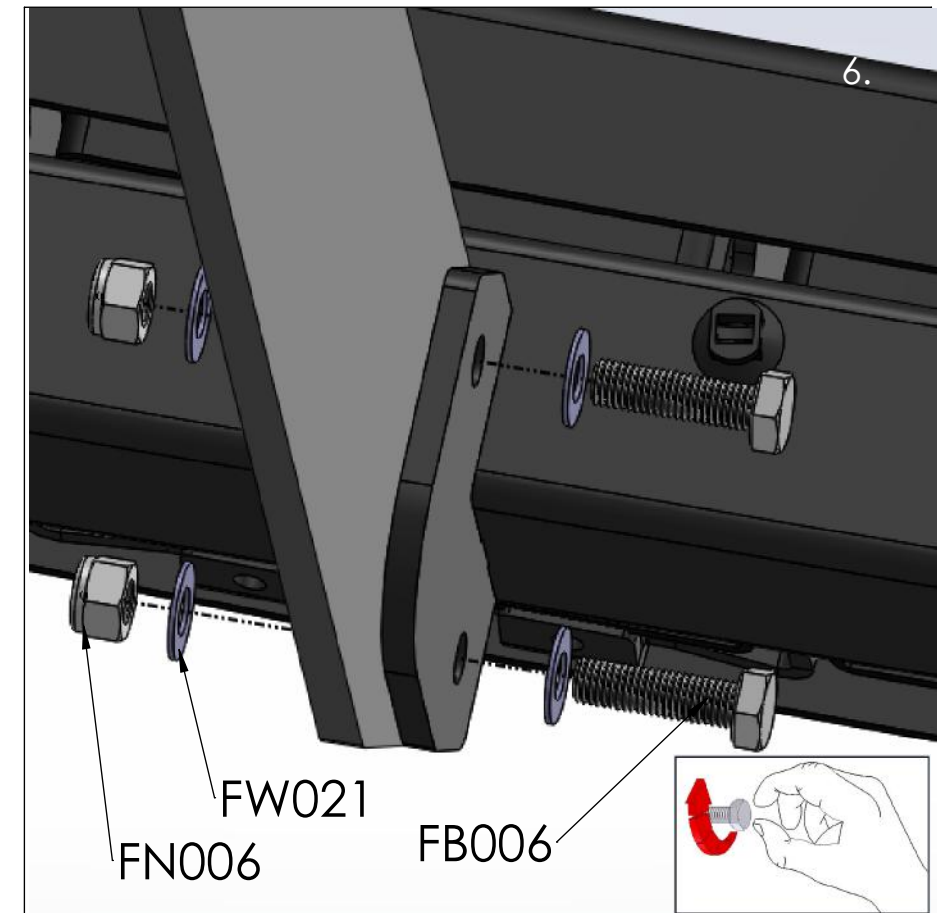
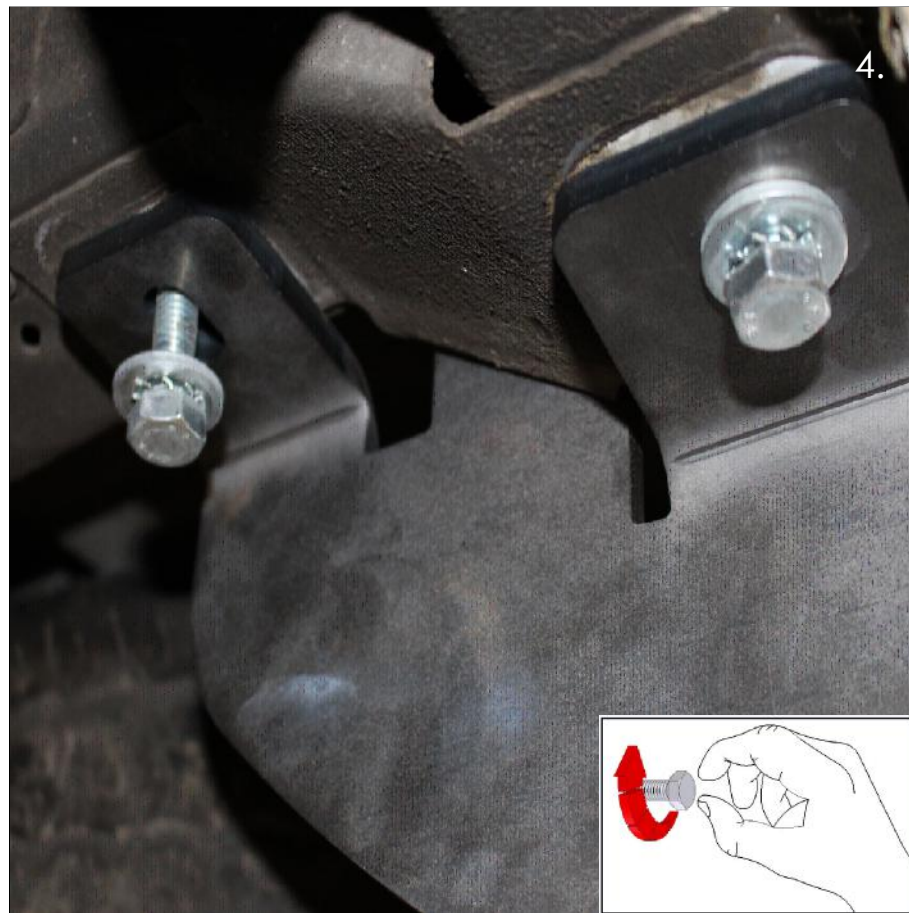
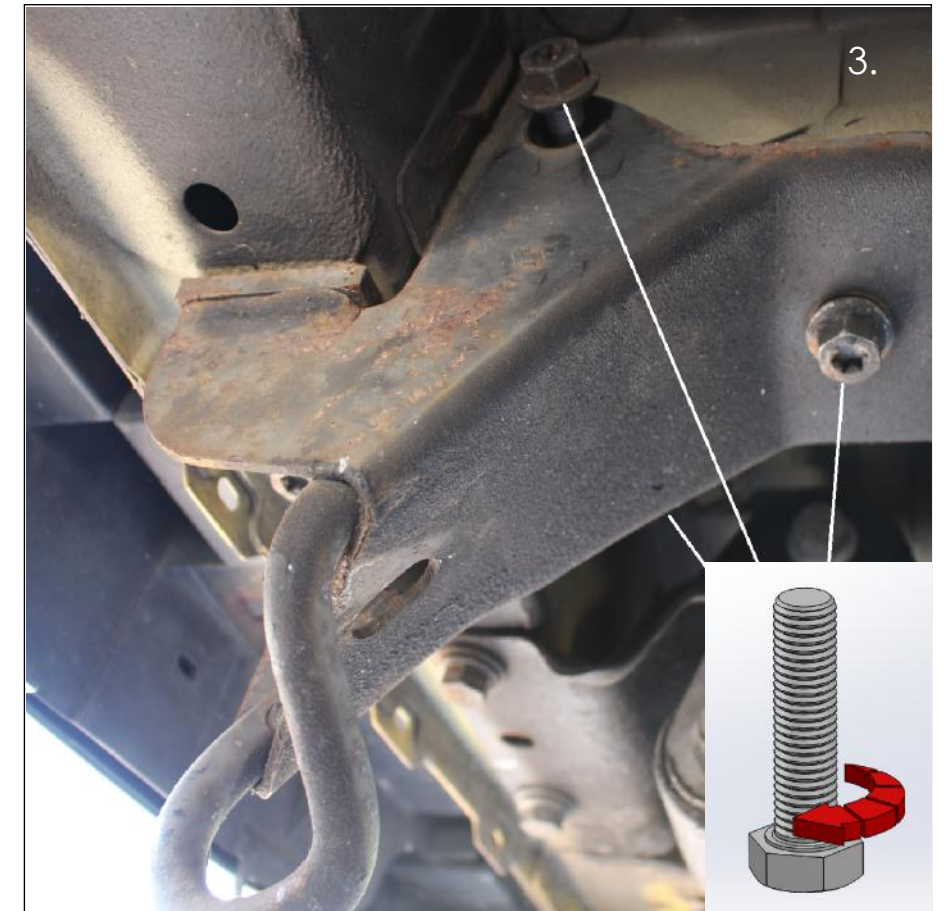
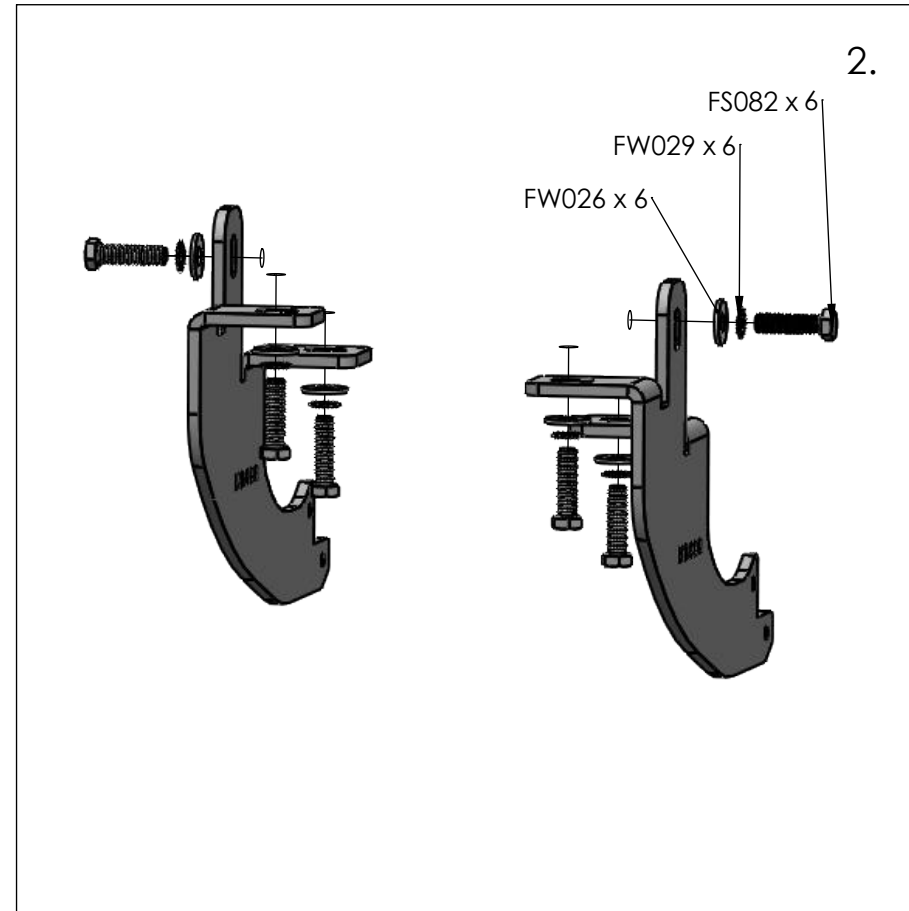
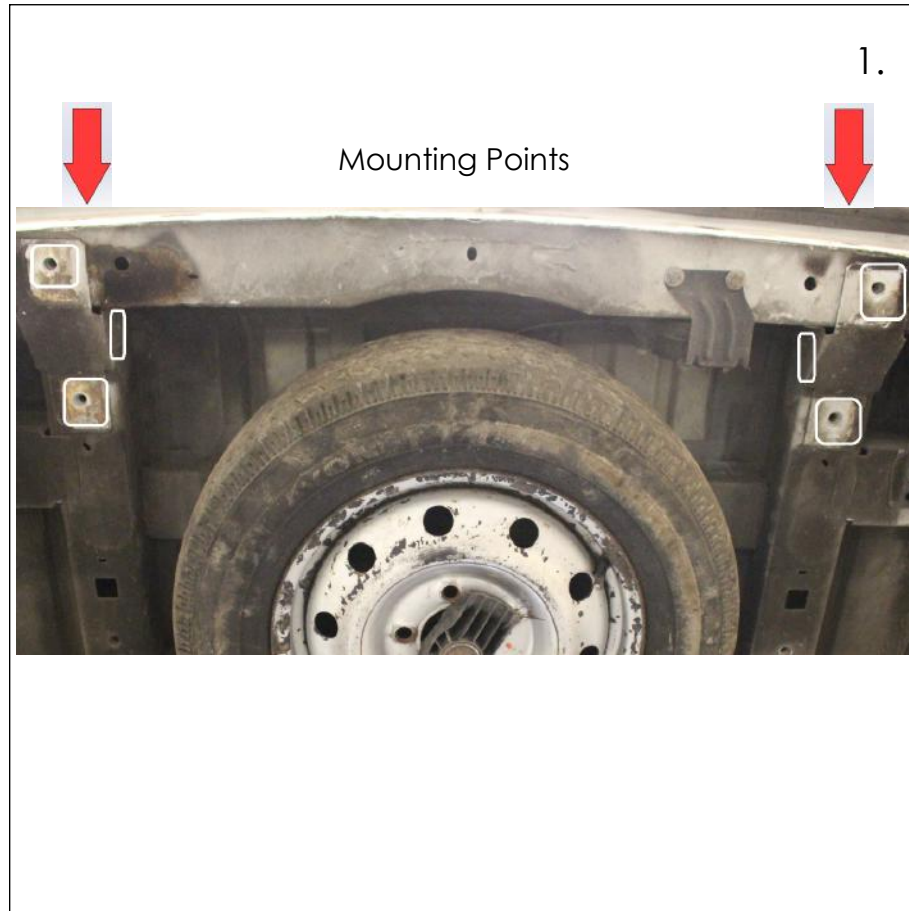

FITTING INSTRUCTIONS

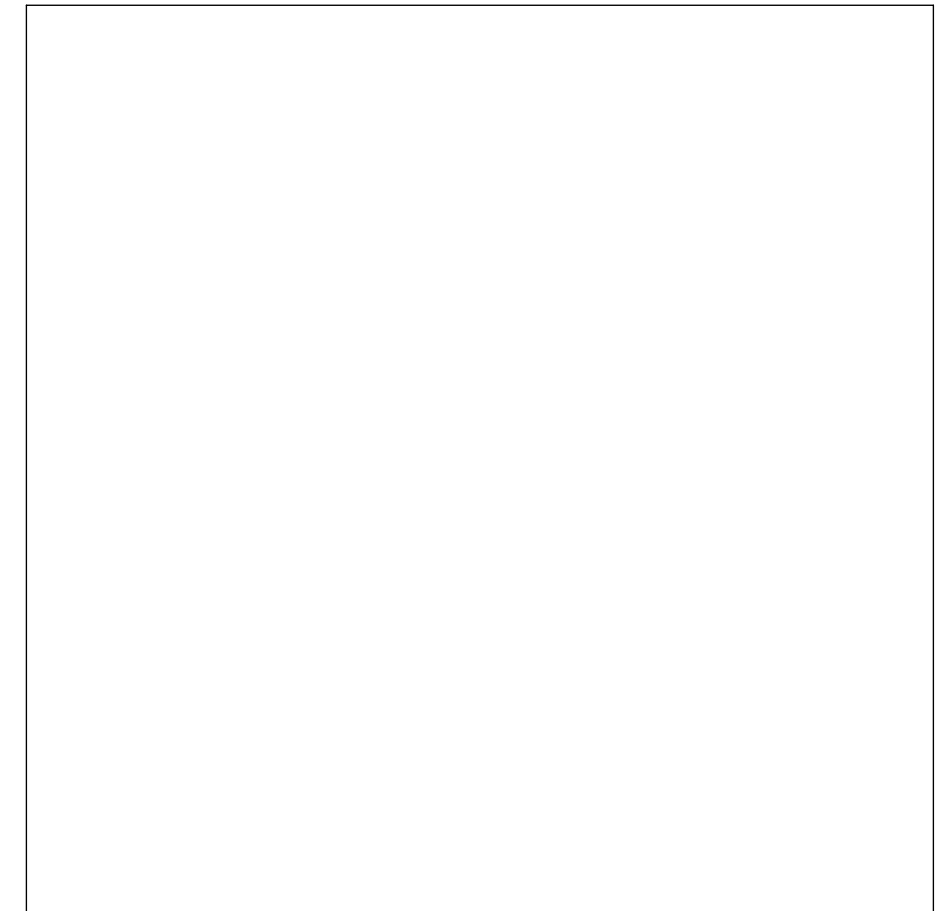
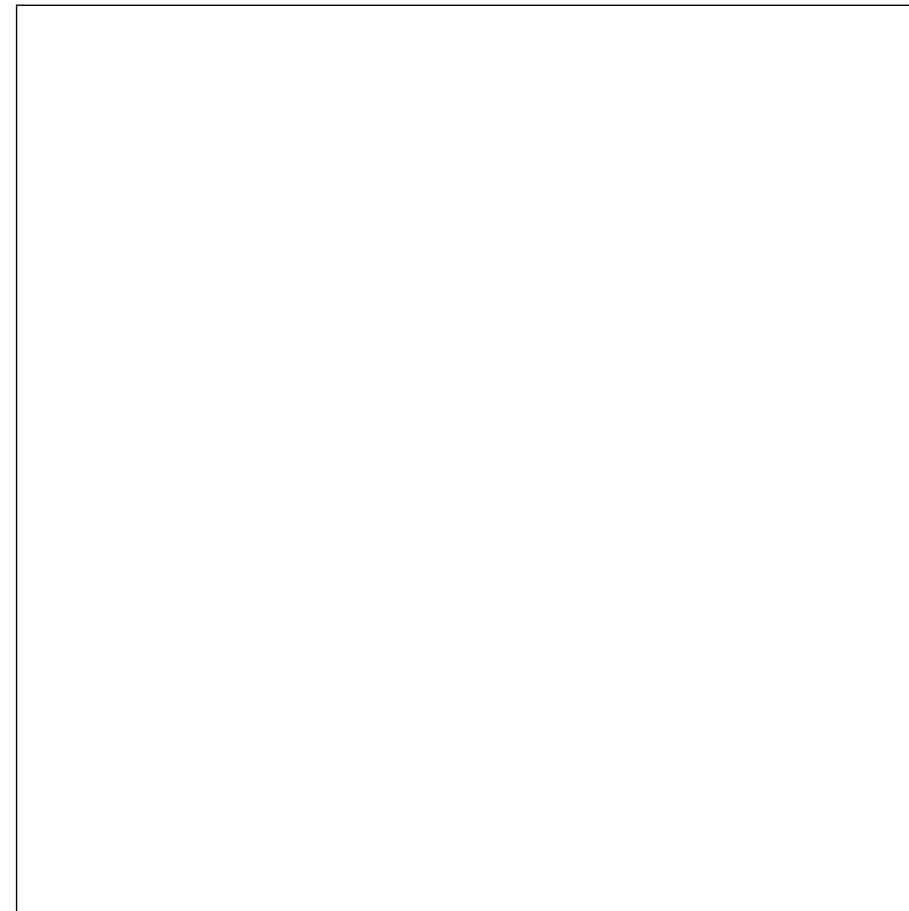
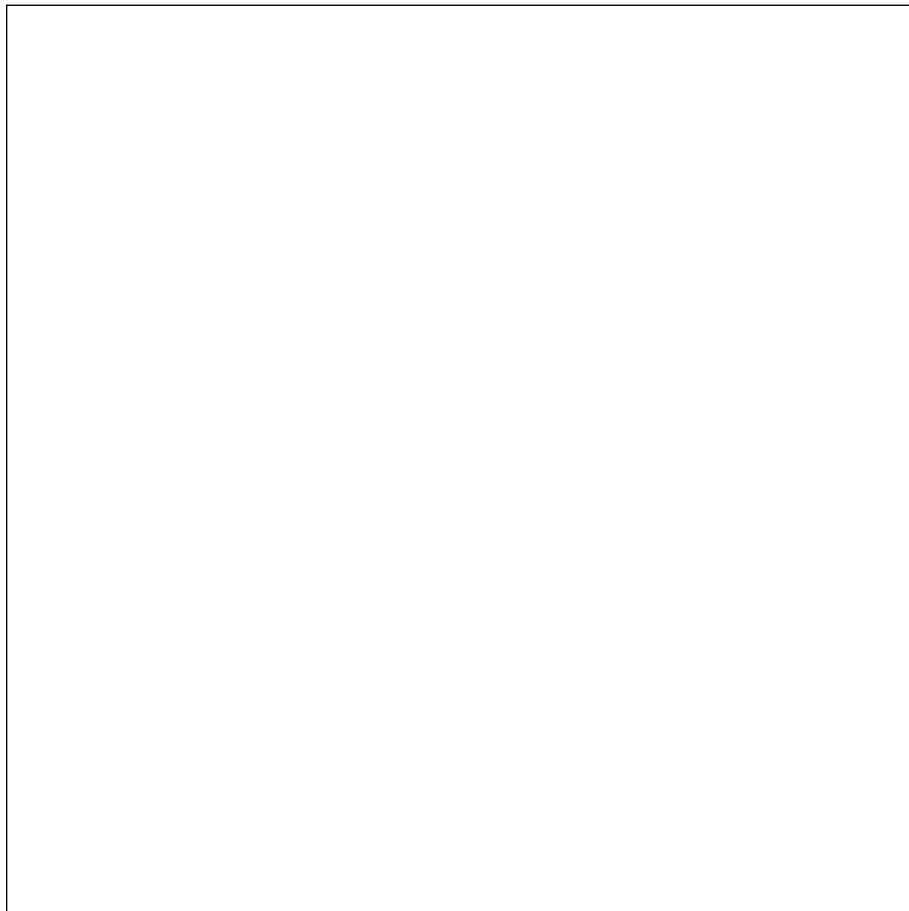
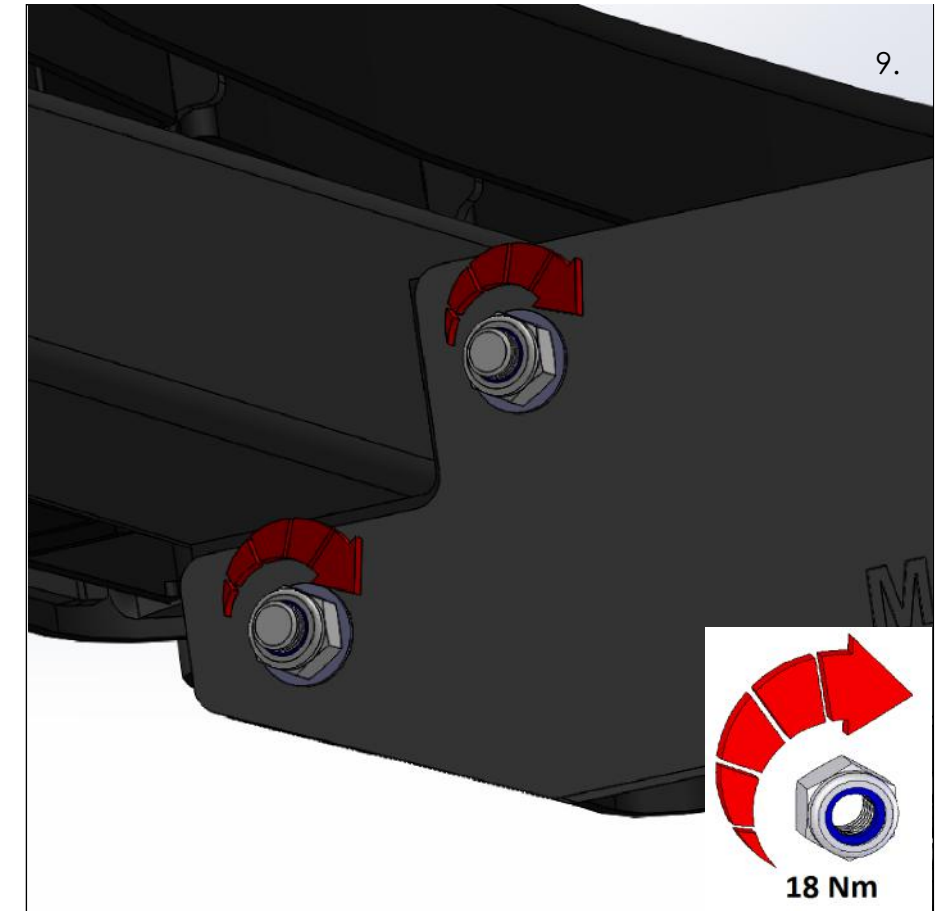

IMPACT STEP FITTING INSTRUCTIONS

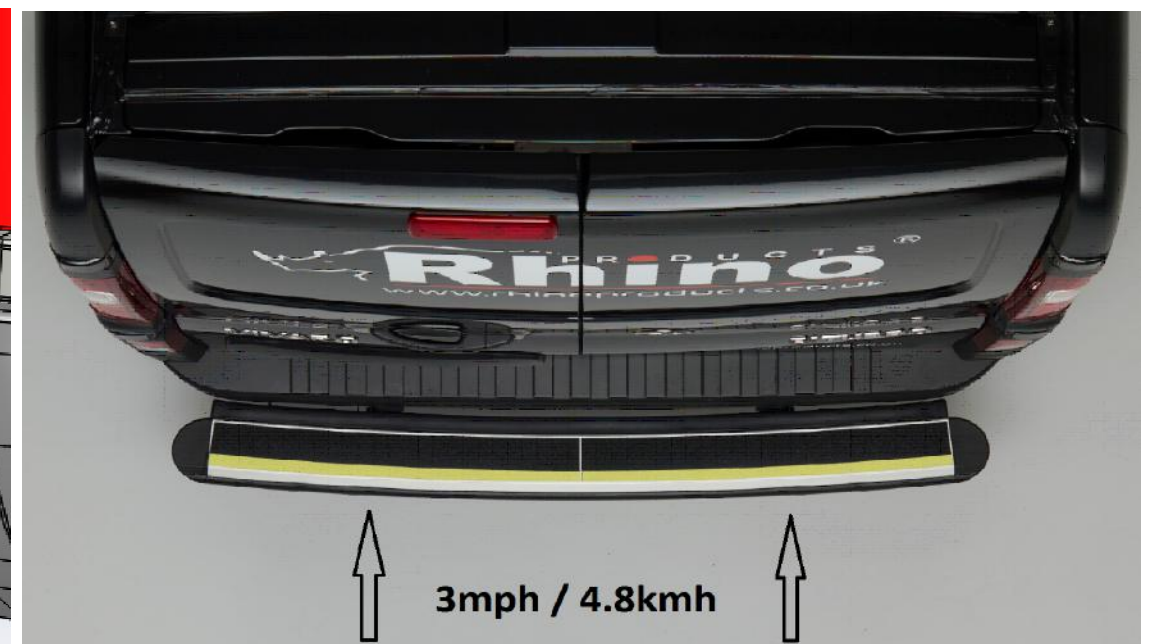
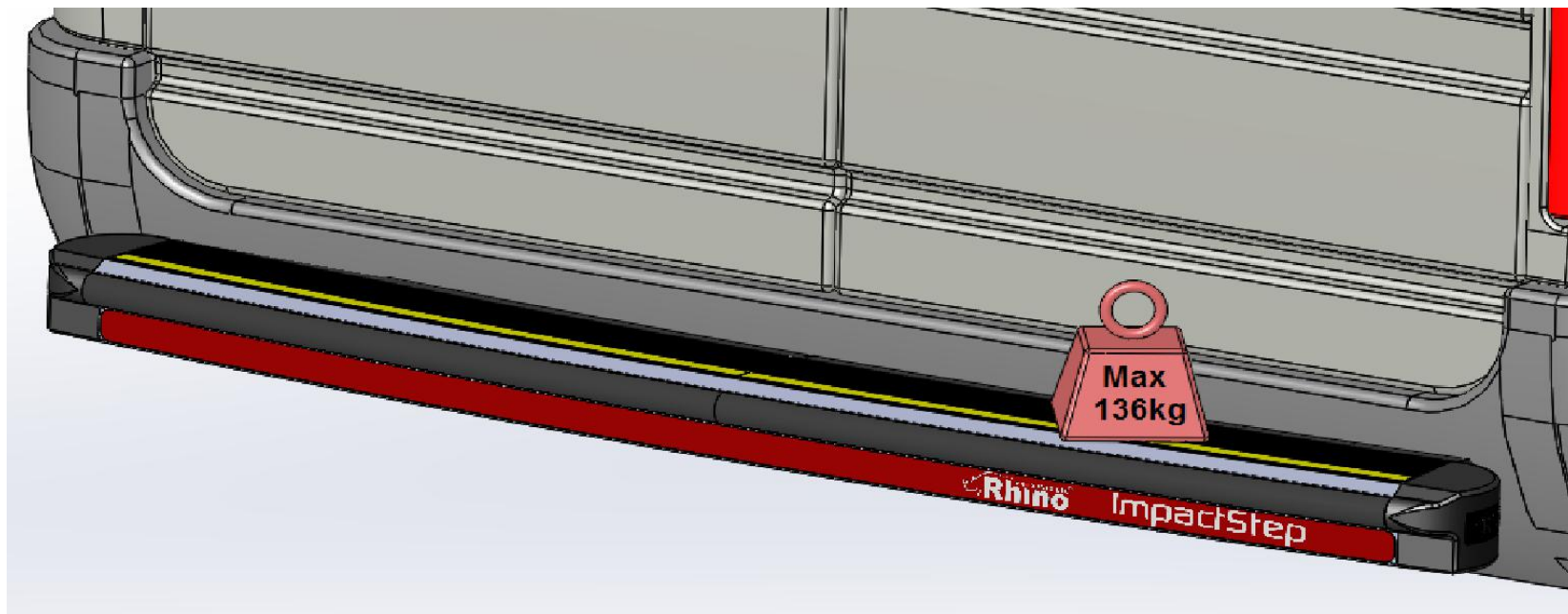
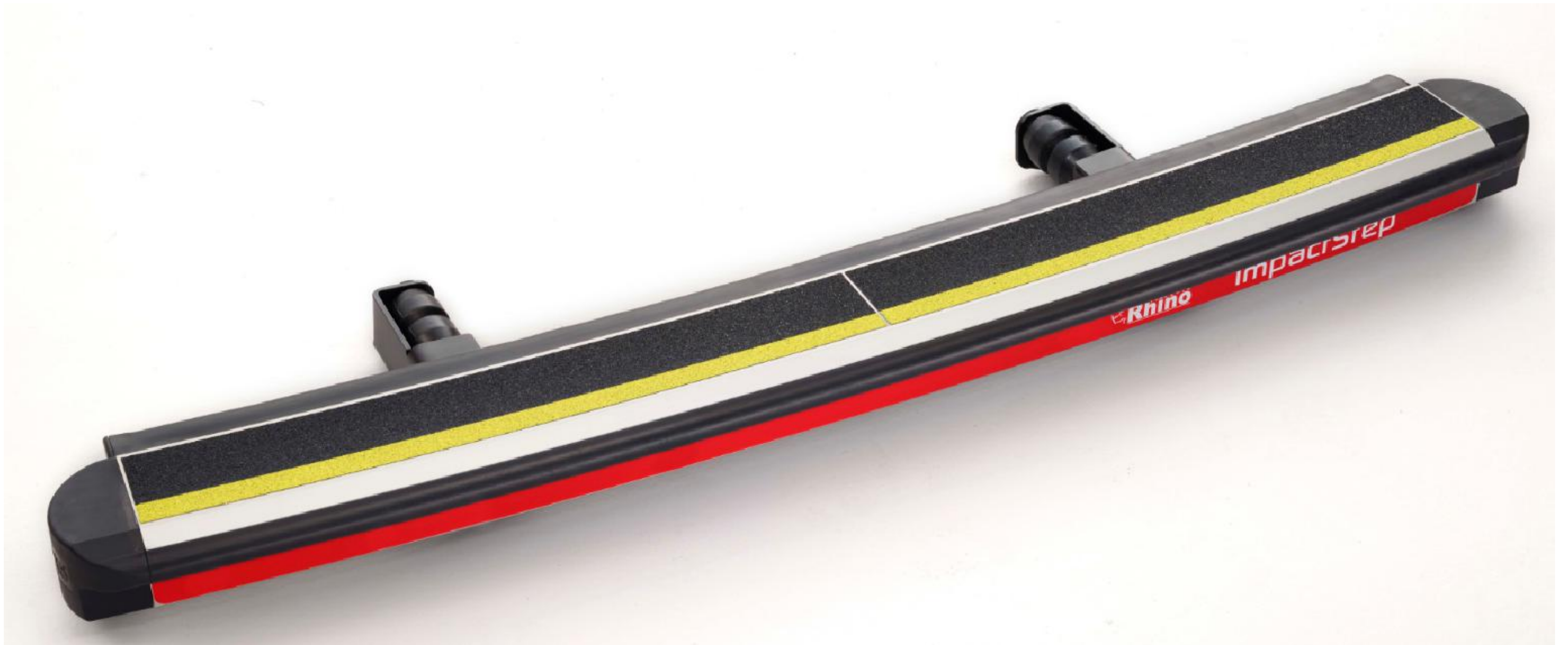

IMPACT STEP FITTING INSTRUCTIONS

FITTING KIT CONTENTS FK888
(1:1)

1.



FW020 (M8) x 4

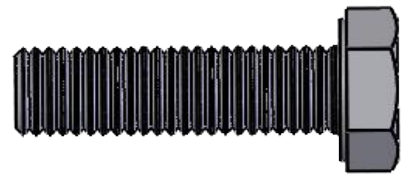

FB006 (M8 x 30) x 4

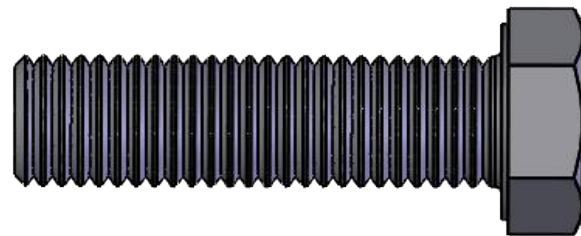

FS082 (M12 x 45) x 6

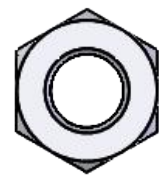

FN006 (M8) x 4

ACCESSSTEP	✓
IMPACT STEP	✗

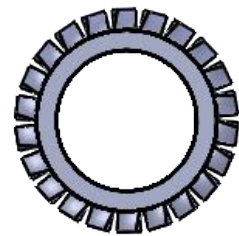

FW029 (M12) x 6

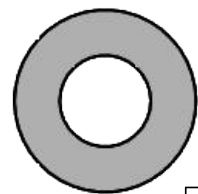

FW021 (M8) x

ACCESSSTEP	8
IMPACT STEP	4

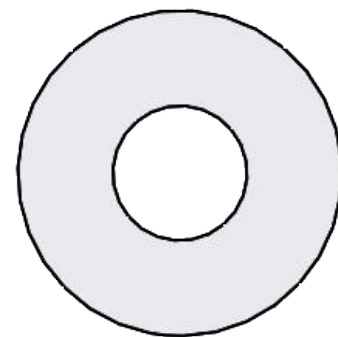

FW026 (M12) x 6

FITTING TIME: 40 Minutes

2.



x 1

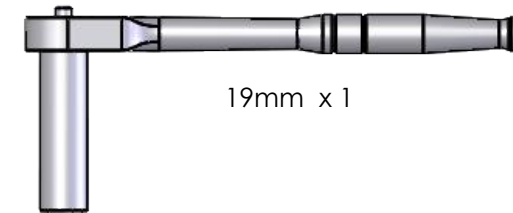

19mm x 1



13mm x 1

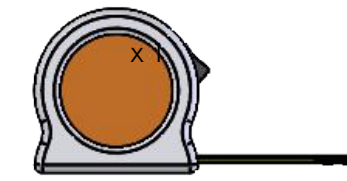

IMPACT STEP FITTING INSTRUCTIONS

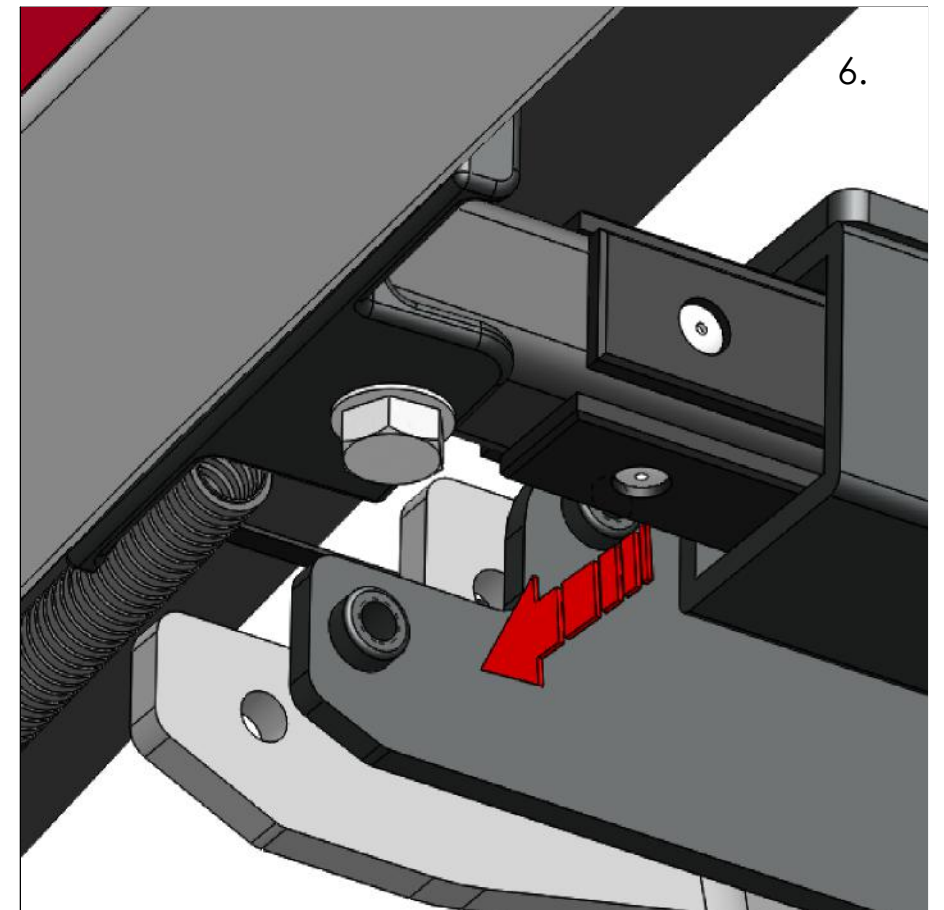
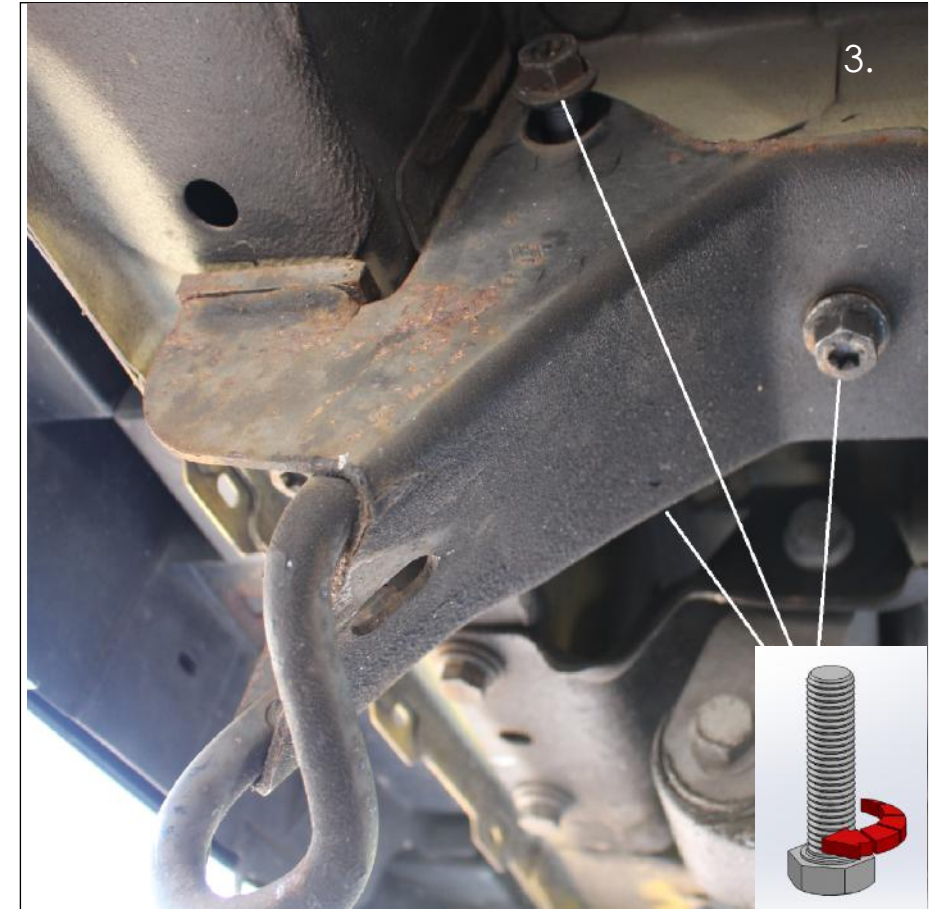
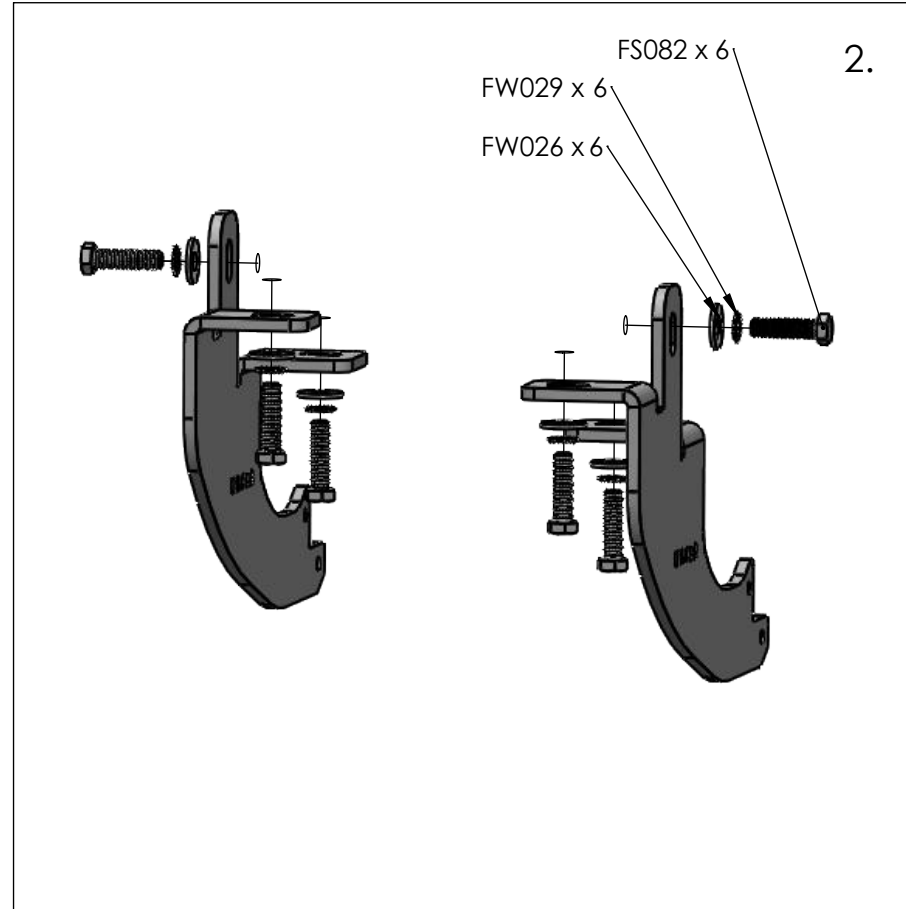
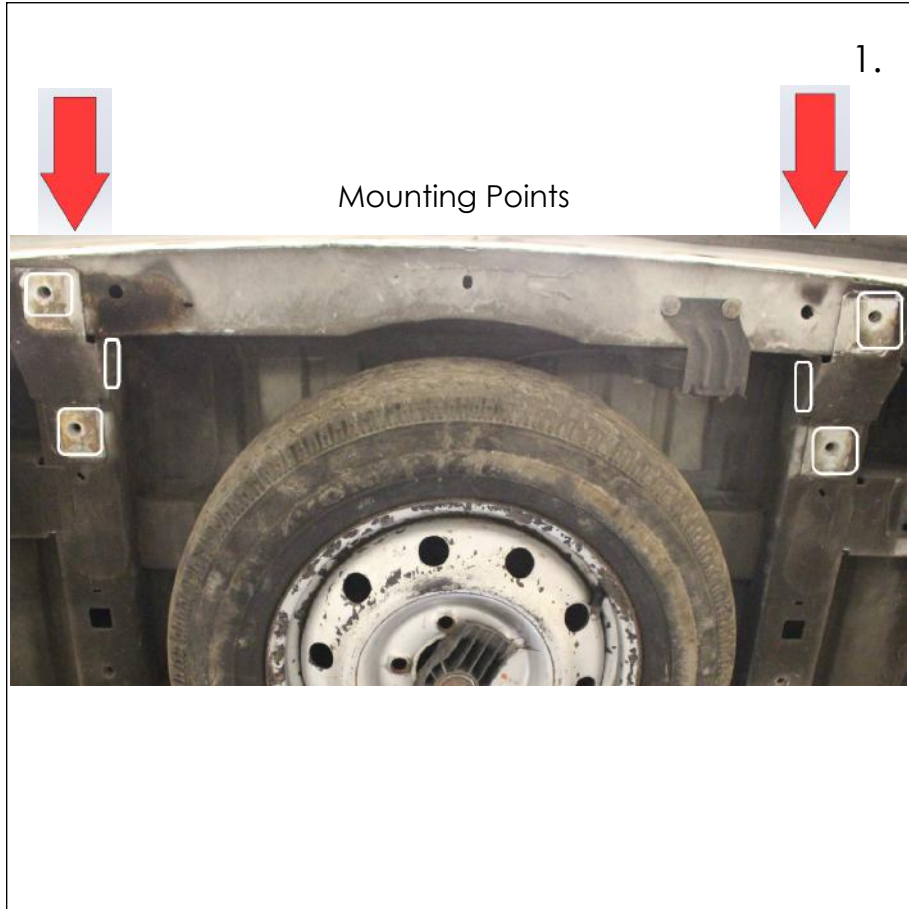

IMPACT STEP FITTING INSTRUCTIONS

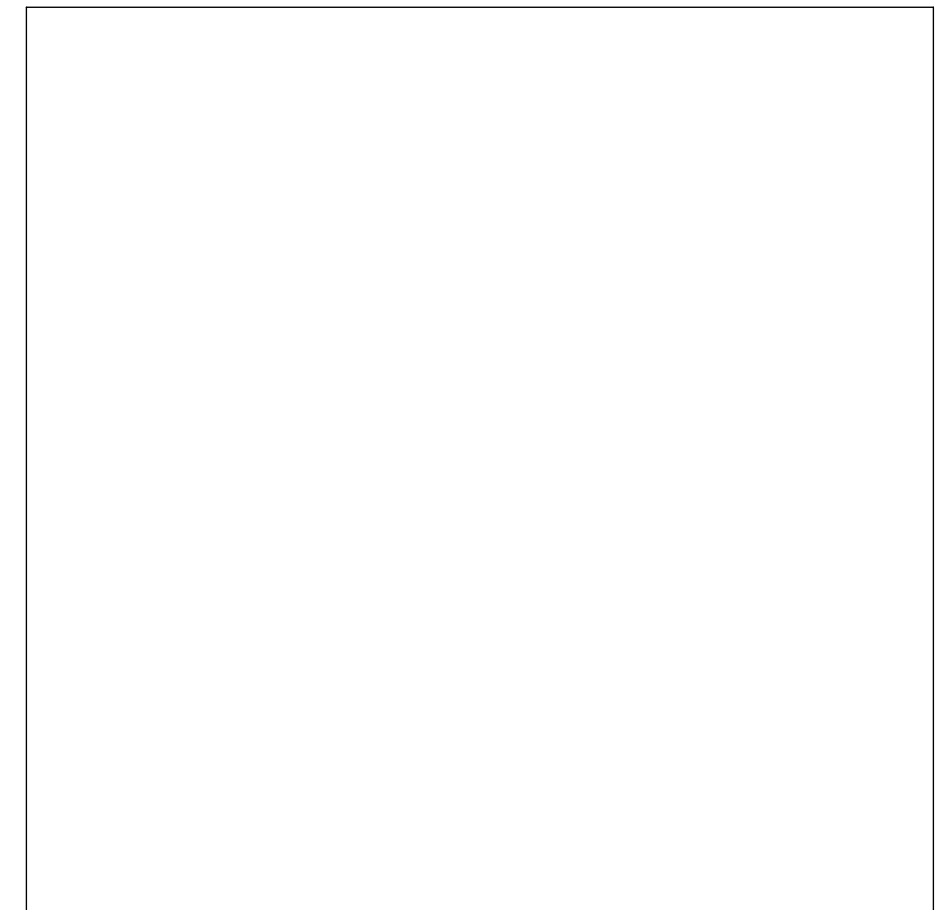
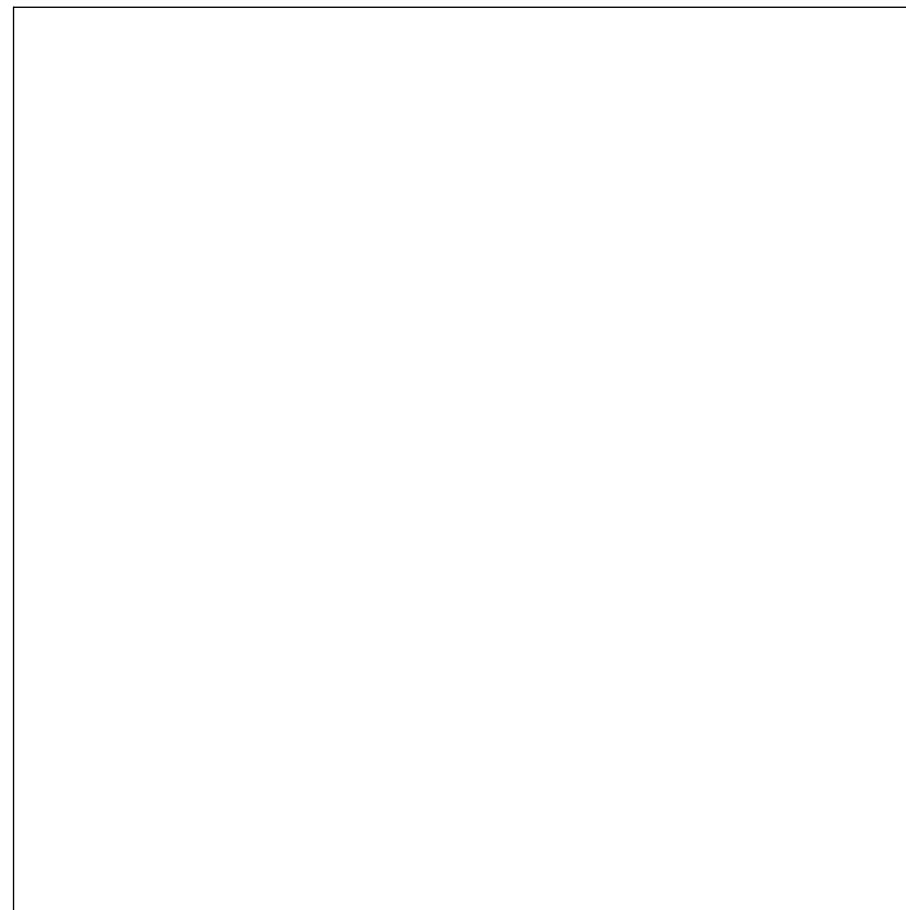
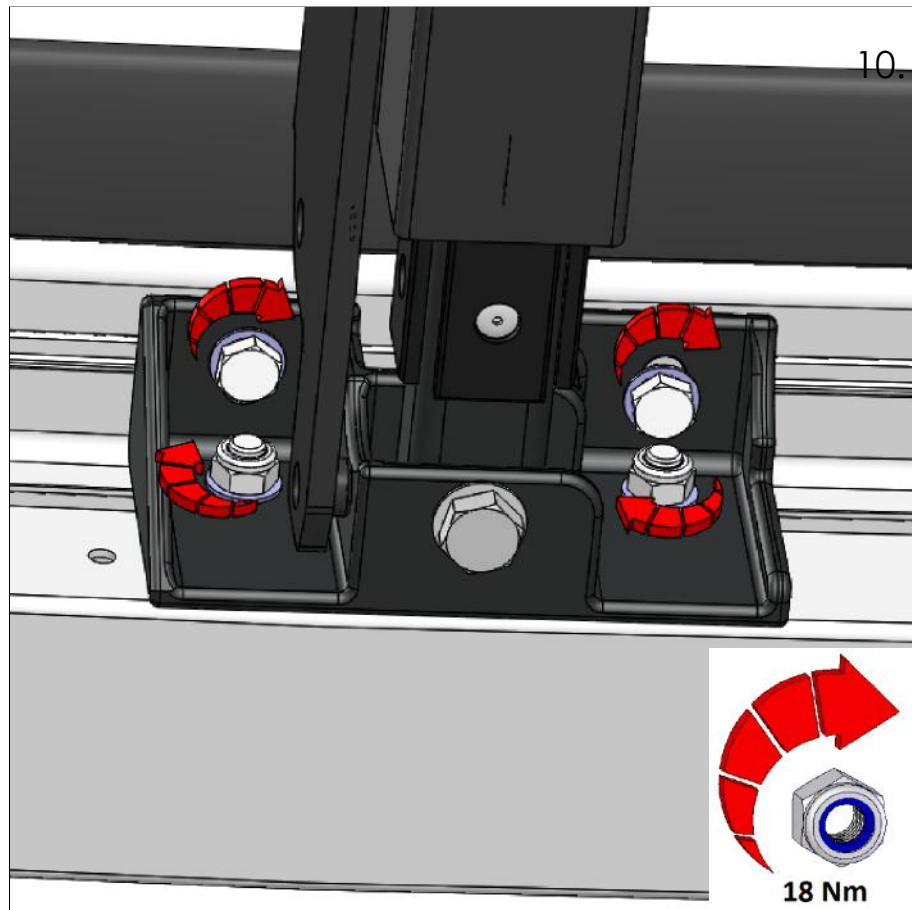
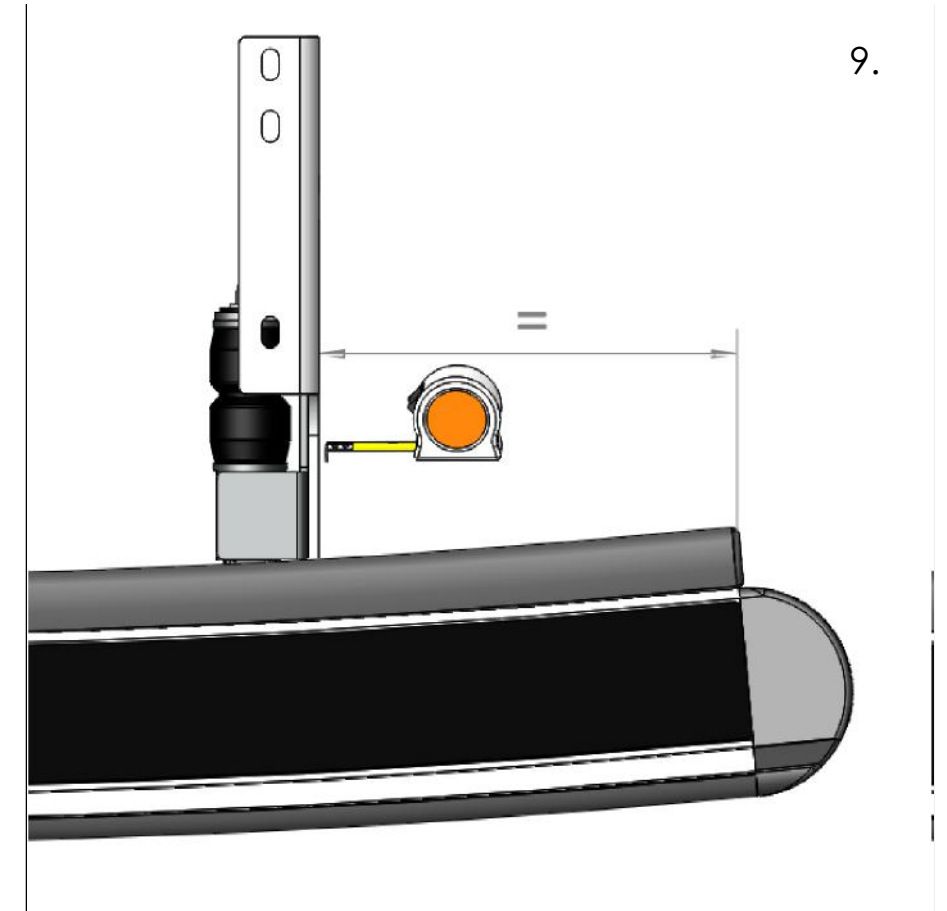
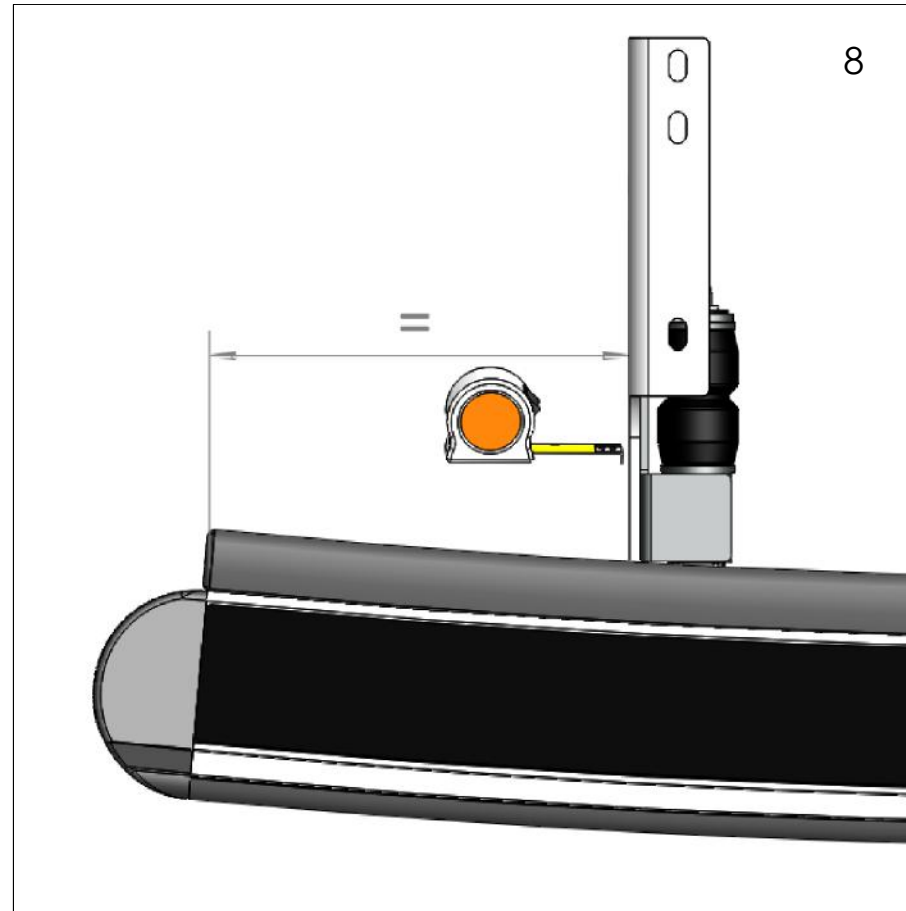
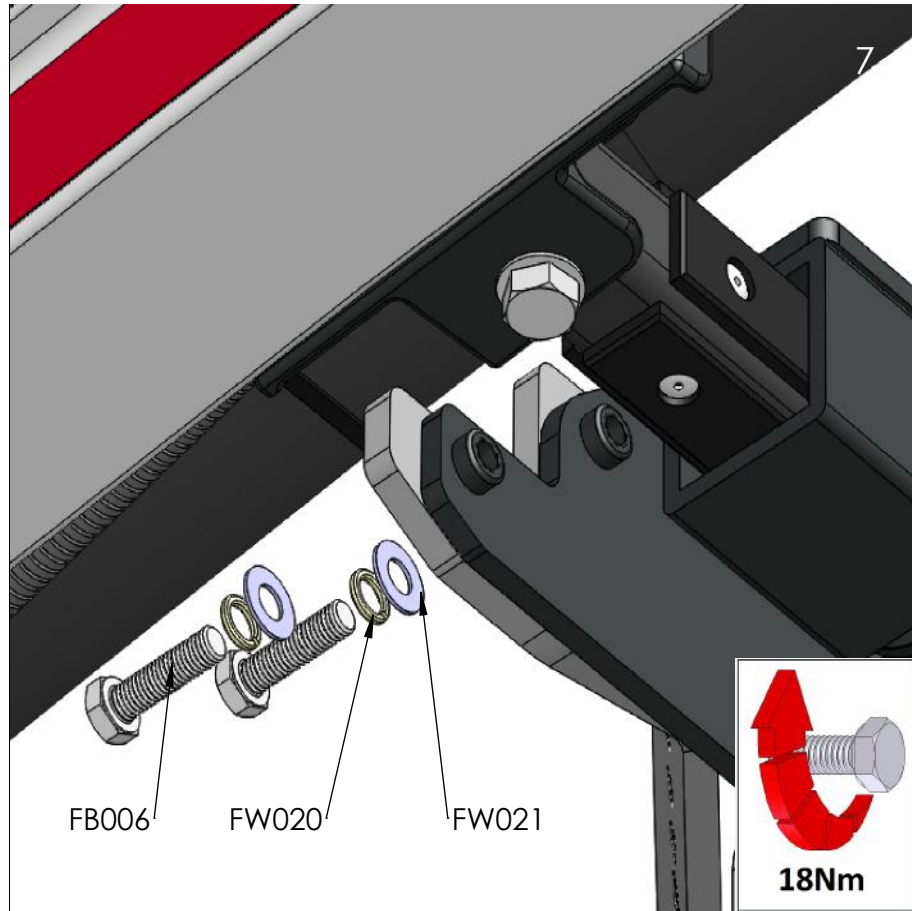



GB: **Important!** The assembly instructions **MUST** be followed to ensure correct operation. Failure to do so can result in invalidated warranty and could affect operation.

FR: **Important!** Vous **DEVEZ IMPÉRATIVEMENT** suivre ces instructions d'assemblage pour assurer un fonctionnement correct du produit. Le non-respect de ces instructions peut entraîner une annulation de la garantie et entraver le bon fonctionnement.

ES: **¡Importante!** Estas instrucciones de montaje **DEBEN** ser seguidas para asegurar el correcto funcionamiento. De no hacerlo, puede resultar inválida la garantía y puede afectar el funcionamiento.

DE: **Wichtiger Hinweis!** Um die fehlerfreie Funktion sicherzustellen, **MUSS** diese Montageanleitung befolgt werden. Andernfalls kann die Garantie erlöschen und die Funktion beeinträchtigt werden.

NL: **Belangrijk!** **VOLG** deze inbouw instructies nauwgezet, zodat het systeem correct functioneert. Onjuiste installatie kan resulteren in een beperking van de werking en tevens de garantie.

IT: **Importante!** **È NECESSARIO** seguire le presenti istruzioni per il montaggio per garantire un corretto funzionamento. In caso contrario, la garanzia potrebbe essere invalidata e il funzionamento potrebbe risentirne.

PL: **UWAGA!** Aby system działał poprawnie, należy postępować dokładnie według instrukcji montażu. Nieprzestrzeganie tego procesu, może wpłynąć na działanie czujników lub też doprowadzić do utraty gwarancji.

SE: **Viktigt!** Monteringsinstruktionerna måste följas noggrant för att säkerställa funktionen. Om så ej görs upphör dels garantin att gälla samt även att själva funktionen kan påverkas.



GB: **ALWAYS** support the sensor adapter from the outside while fitting the vehicle sensors.

FR: Toujours veiller à un bon support des adaptateurs du capteur lors du montage des capteurs du véhicule.

ES: Sujete siempre el adaptador de sensor mientras instale sensores de vehículos.

DE: Es ist darauf zu achten, dass der Sensoradapter beim Anbringen der Fahrzeugsensoren immer gestützt wird.

NL: Ondersteun de sensorhouders tijdens de installatie van de voertuigsensors.

IT: Sostenere sempre l'adattatore del sensore durante l'installazione dei sensori del veicolo.

PL: Zawsze podtrzymuj adaptory podczas montażu czujników.

SW: Ge sensoradaptern stöd när fordonets sensorer monteras.

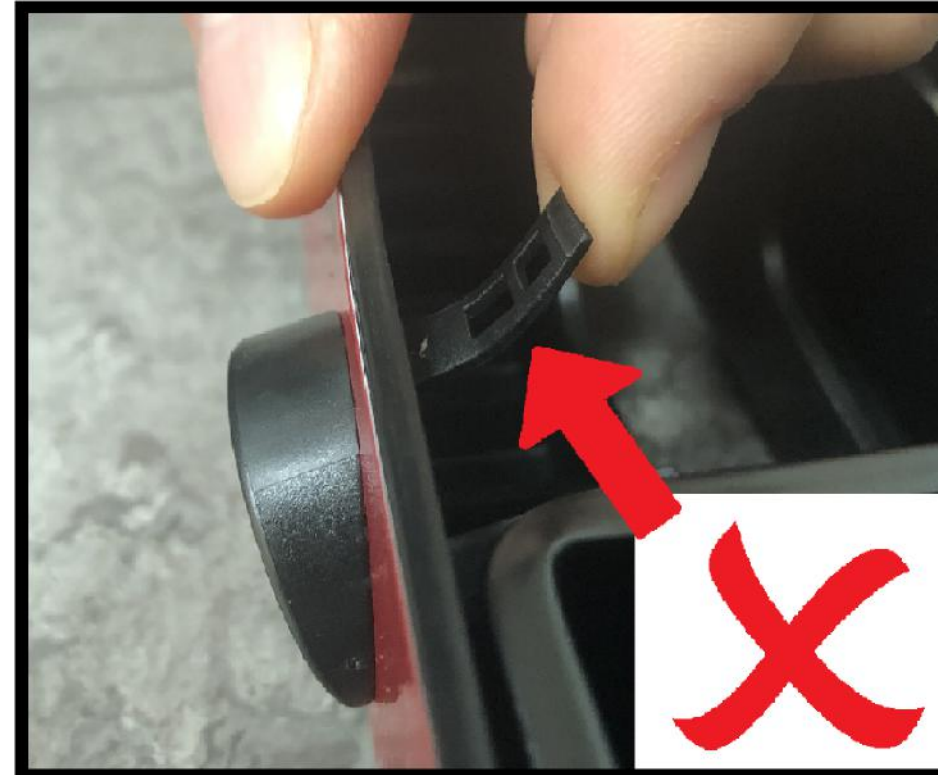

GB: **DO NOT** over bend the adapter arms when inserting the vehicle sensors.

FR: Ne pas courber les bras de l'adaptateur lors de l'insertion des capteurs.

ES: No doble demasiado los brazos de los adaptadores cuando inserte sensores.

DE: Die Adapterarme beim Einsetzen der Sensoren nicht überbiegen.

NL: Buig de sensorhouder-armen niet te ver naar buiten

IT: Non piegare eccessivamente i bracci dell'adattatore durante l'inserimento dei sensori.

PL: Podczas wkładania czujników parkowania do adapterów, należy pamiętać, aby nadmiernie nie zginać ramion adaptera.

SW: öj ej adapterns armar för mycket när sensorer monteras.

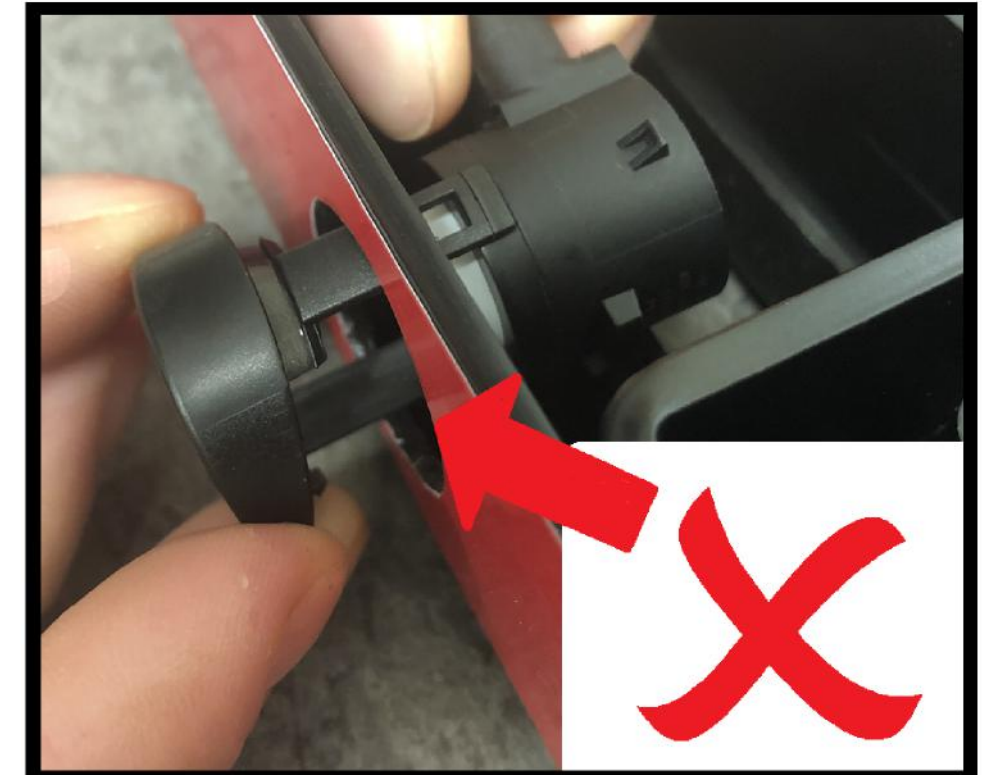

GB: **DO NOT** de-mount the adapters from the step when fitting the sensors

FR: Veillez à ne pas démonter les adaptateurs du marchepied lors du montage des capteurs.

ES: Tenga cuidado en no desmontar adaptadores del escalón cuando instale sensores.

DE: Darauf achten, dass beim Anbringen der Sensoren keine Adapter von der Trittstufe abmontiert werden.

NL: Zorg ervoor dat de sensorhouders niet uit de opstap worden gedrukt, tijdens de installatie van de sensors.

IT: Fare attenzione a non smontare gli adattatori dal gradino durante l'installazione dei sensori.

PL: Nie należy wyjmować adapterów ze stopnia, podczas montażu czujników.

SW: Iakttag försiktighet när sensorerna monteras så att inte adapterna skjuts ur steget.

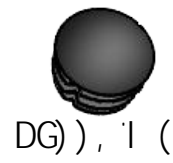

DG), '1 (



DG **'1 (



DG -+'1 &



&\$%\$%+&!`DG\$(' '1 (

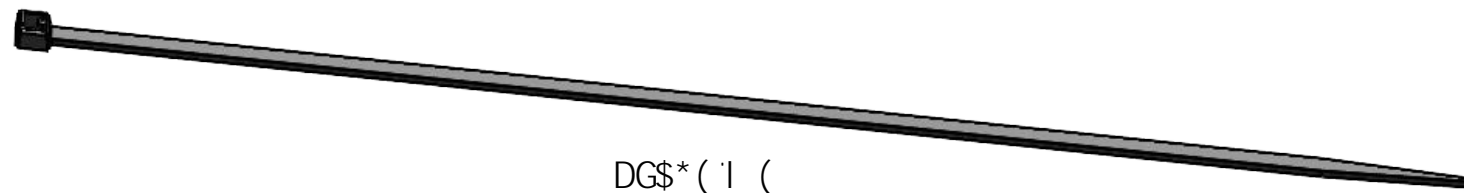

DG\$*('1 (



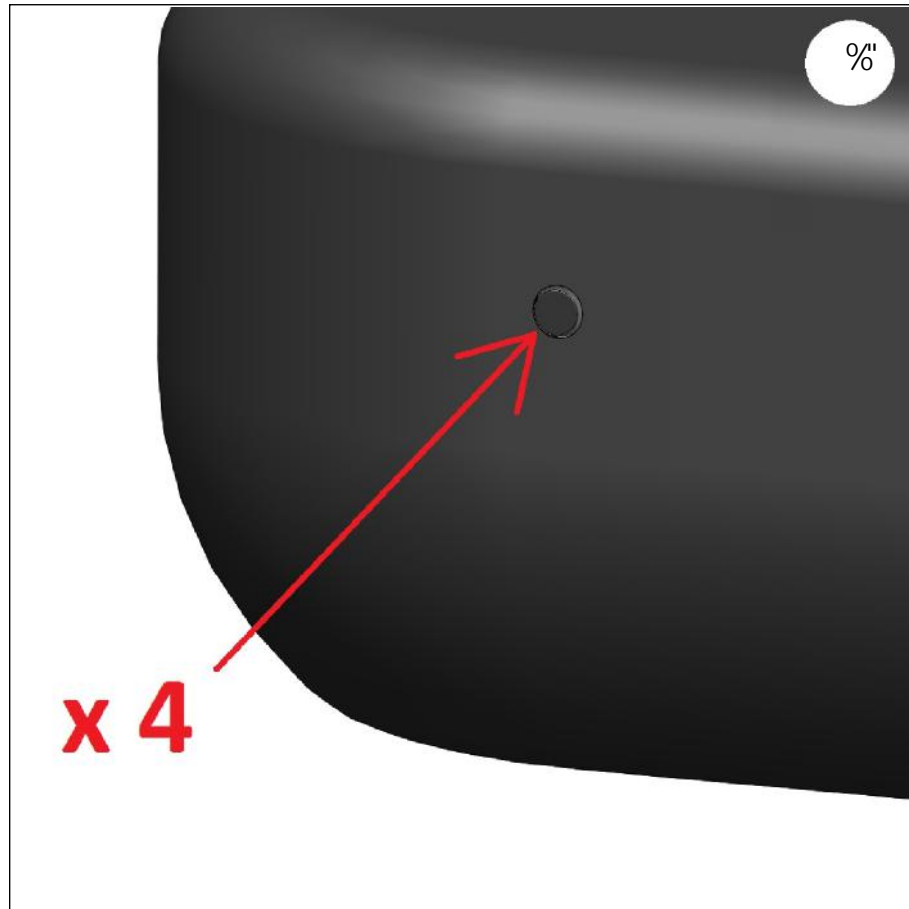

2017- VW Crafter 2017- MAN TGE	2014- VW Transporter T6 1999-2014 VW T5	2014- Ford Transit 2013- Ford Transit Custom	2006- Mercedes Sprinter 2006-2017 VW Crafter	&"
✓	✗	✓	✓	
2006- Citroen Relay/Jumper 2006- Peugeot Boxer 2008- Fiat Ducato 2022- Vauxhall/Opel Movano	2016- Toyota Proace 2018- Peugeot Expert	2019- Vauxhall/Opel Vivaro 2018- Citroen Dispatch 2022- Fiat Scudo	2010- Renault Master 2010-2021 Vauxhall/Opel Movano 2010 - Nissan NV400	
✓	✗	✗	✓	

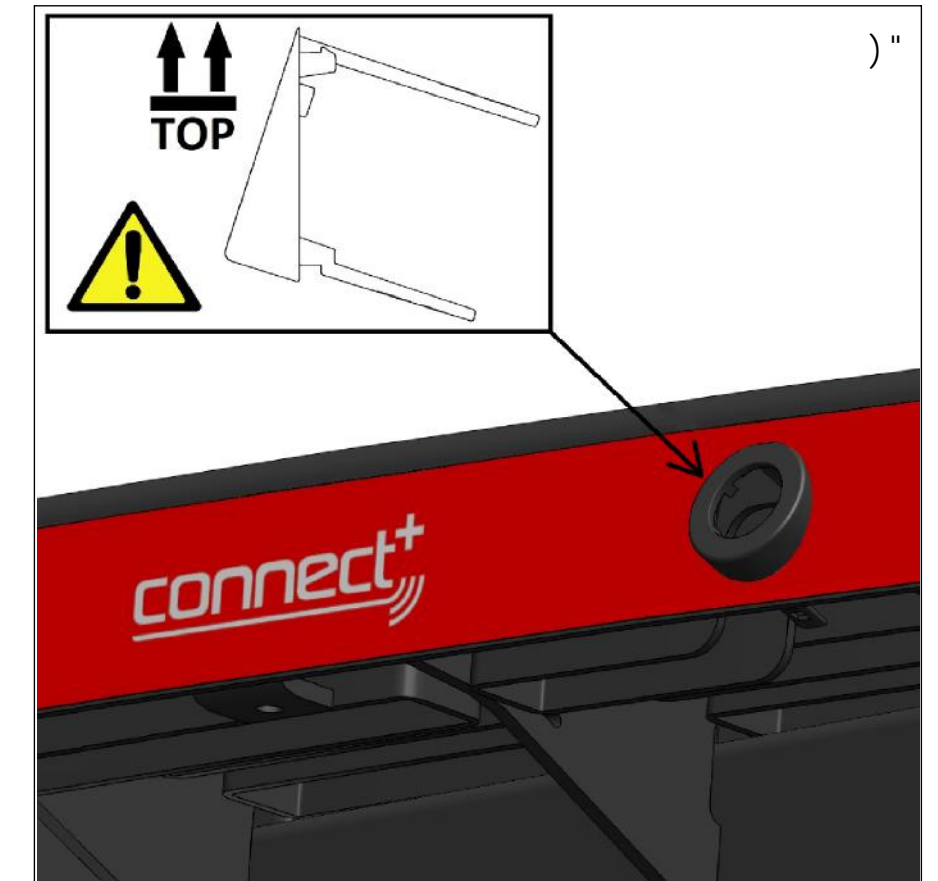
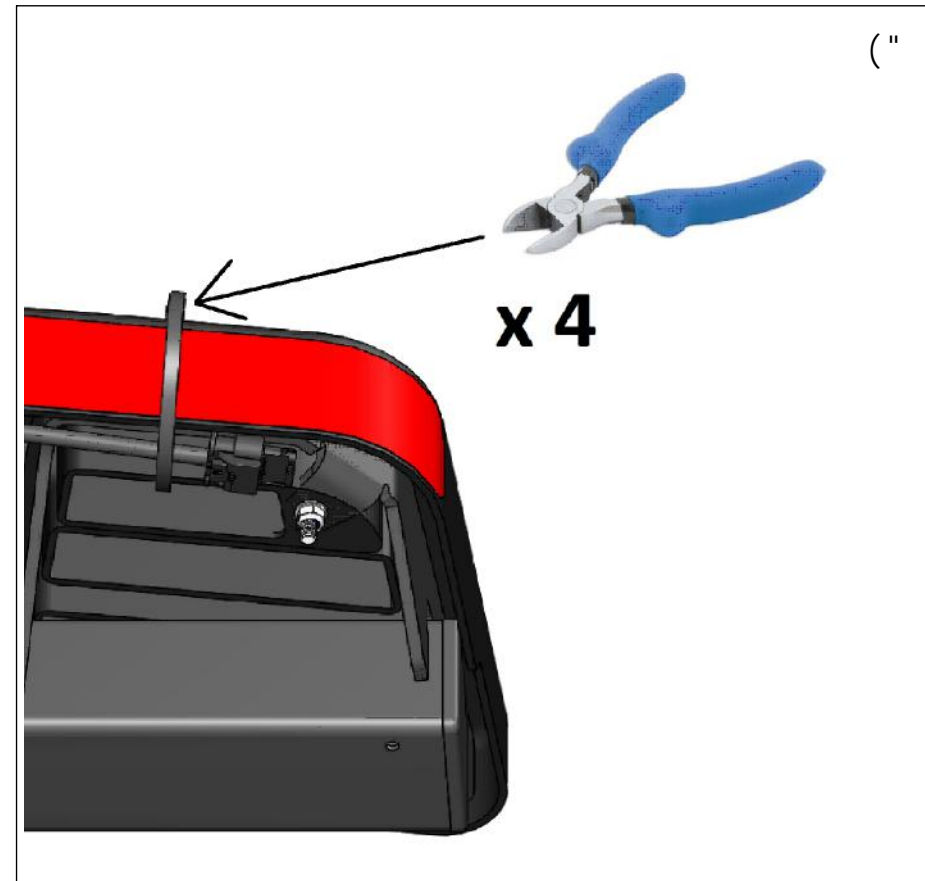
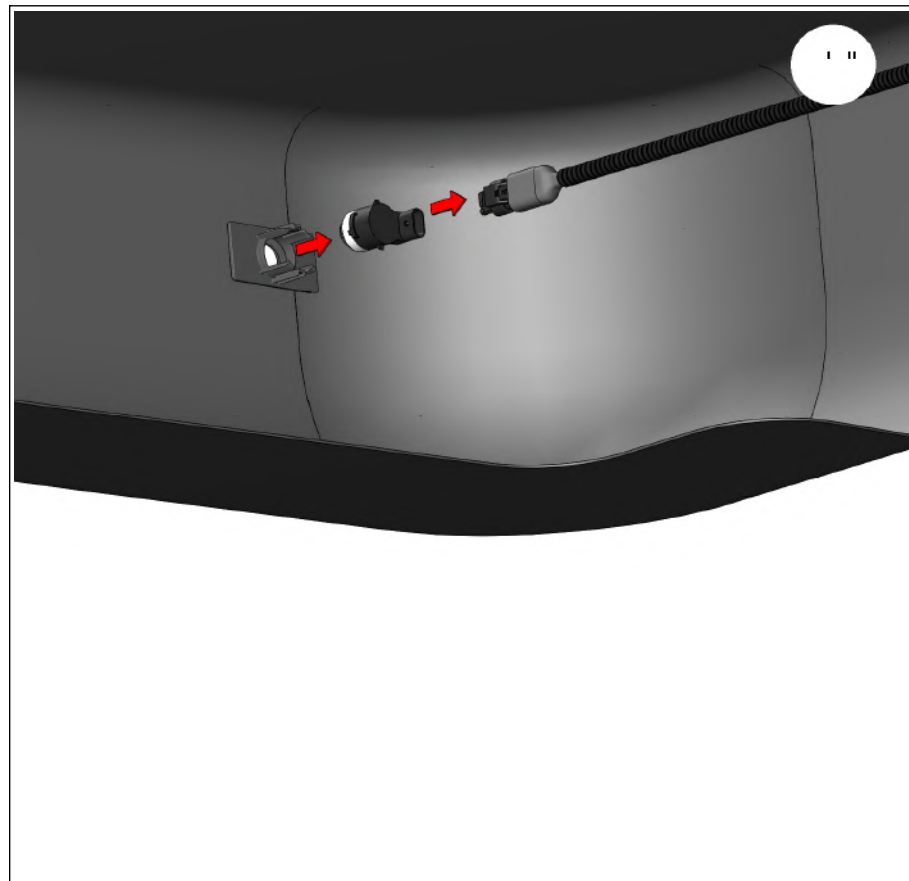

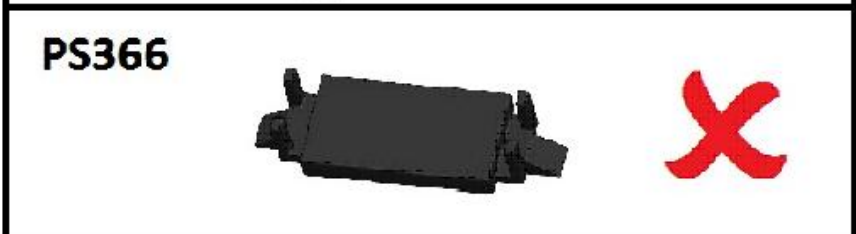
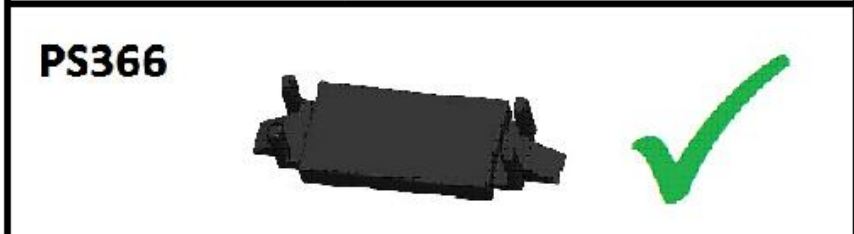
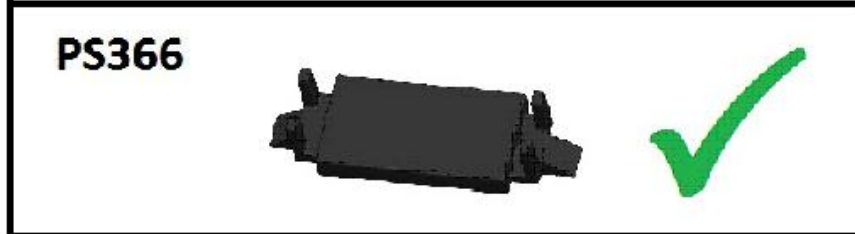
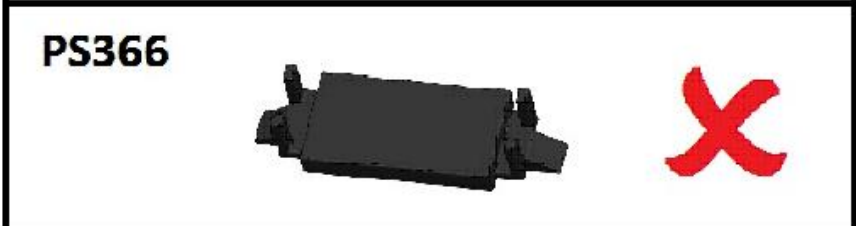
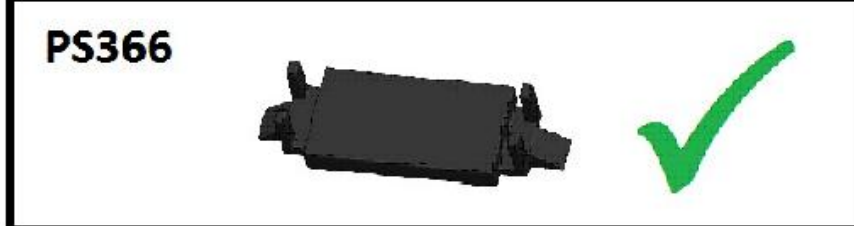
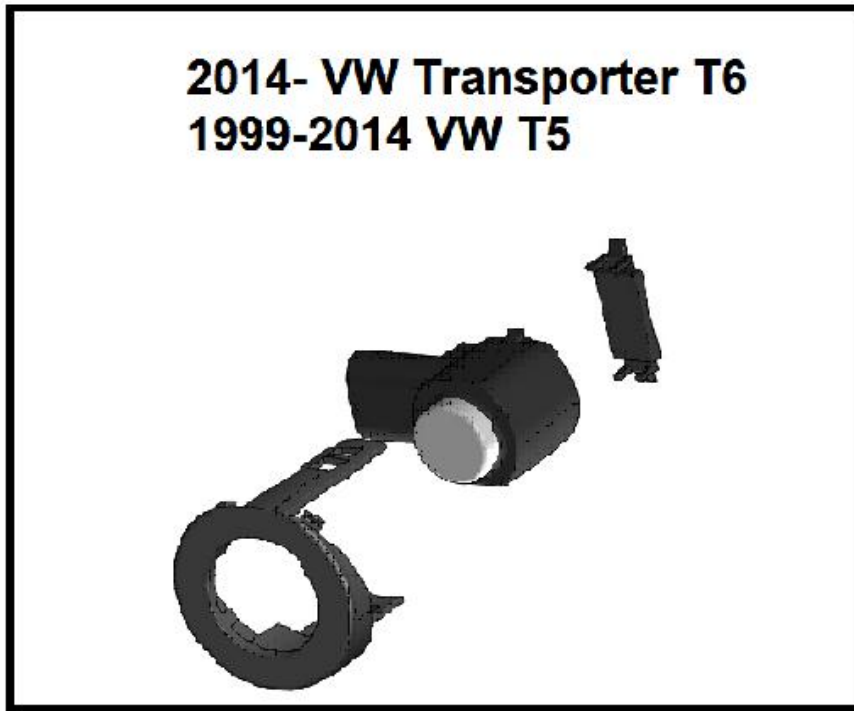
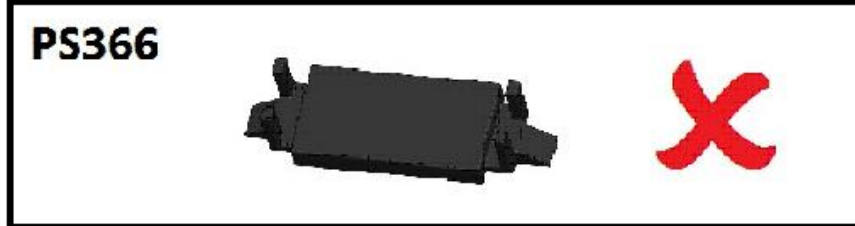

**2020- Ford Transit
(JU5T-15K859-BC)**
**2018- Ford Transit Custom
(HU5T-15K859-AAW)**



PS366



**2014-20 Ford Transit
(GK2T-15K859-EA)**
**2012-18 Ford Transit Custom
(CJ5T-15K859-AWW)**



PS366

