

FITTING INSTRUCTIONS



Some vehicles may require VW parts:

1 x Plastic Rail (7H0 807 723)

8 x Gasket (357 853 586 B)

8 x Clip (701 867 299)



FITTING INSTRUCTIONS

FITTING KIT CONTENTS FK899
(1:1)



FW020 (M8) x 4

ACCESSSTEP	✗
IMPACT STEP	✓



FS066 (M8) x 4



FB006 (M8) x 4

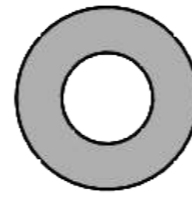

FW021 (M8) x 8



FN006 (M8) x 4

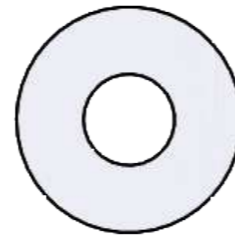

FW002 (M8) x 4

FITTING TIME: 60 Minutes

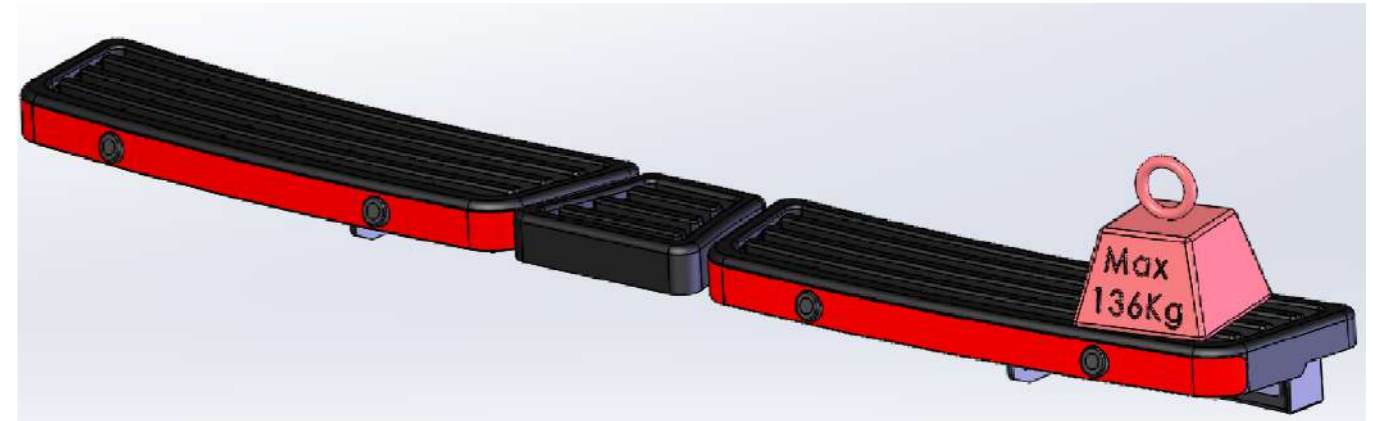

x1

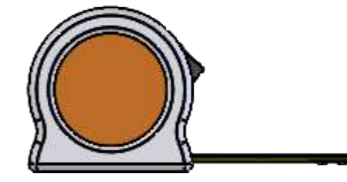

x1

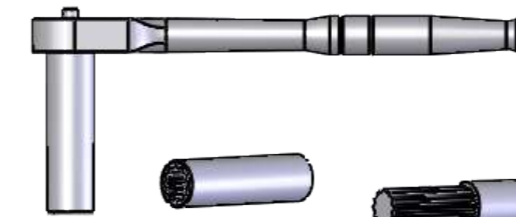

13mm

T20 Torx



13mm x 2

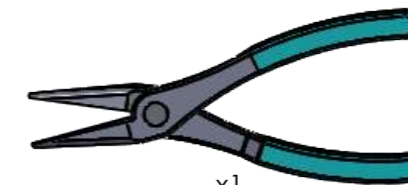

x1



x1



Clip remover x 1

FITTING INSTRUCTIONS

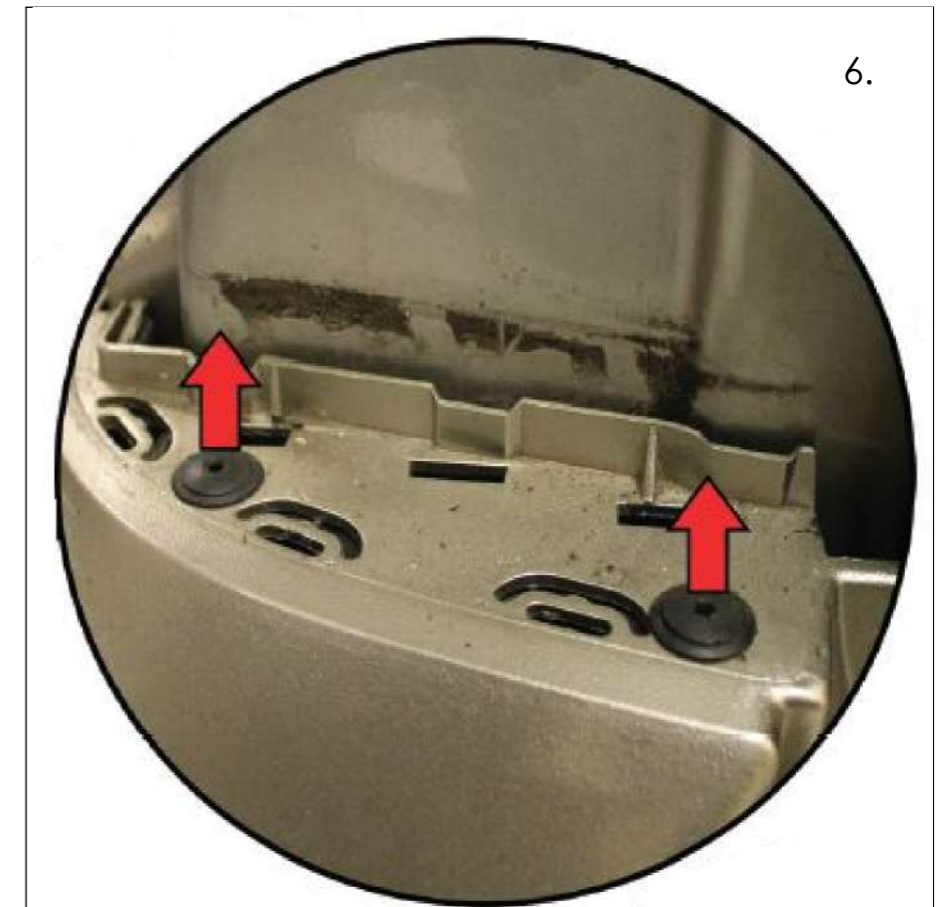
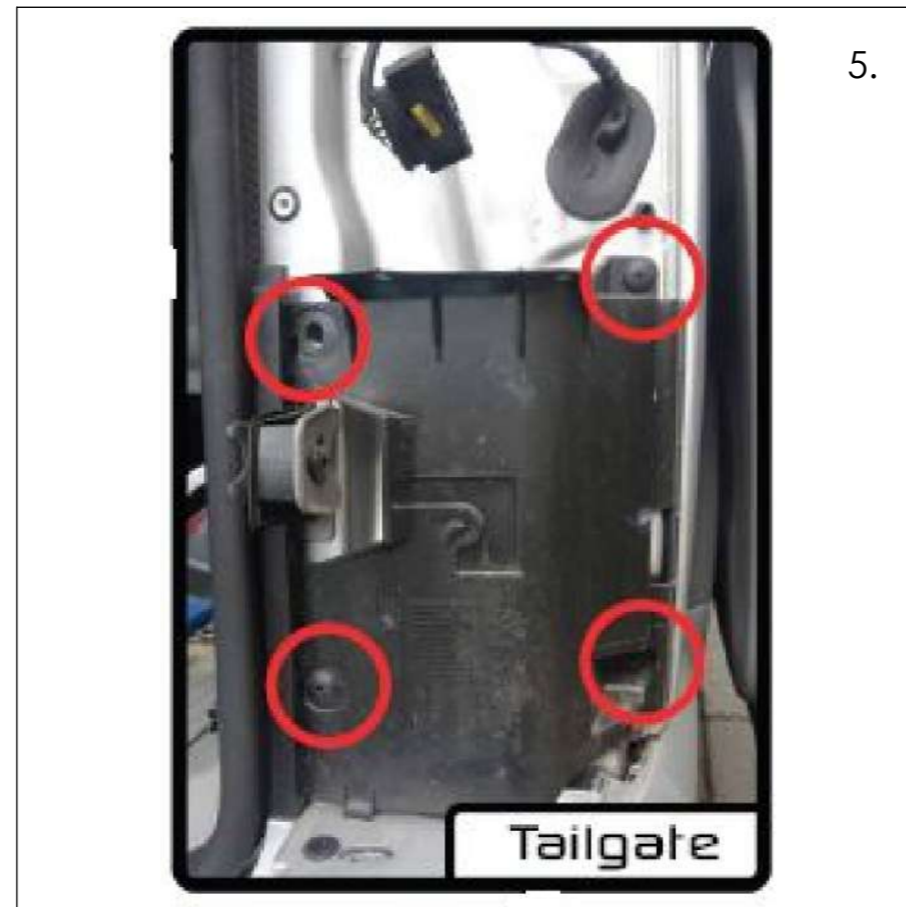
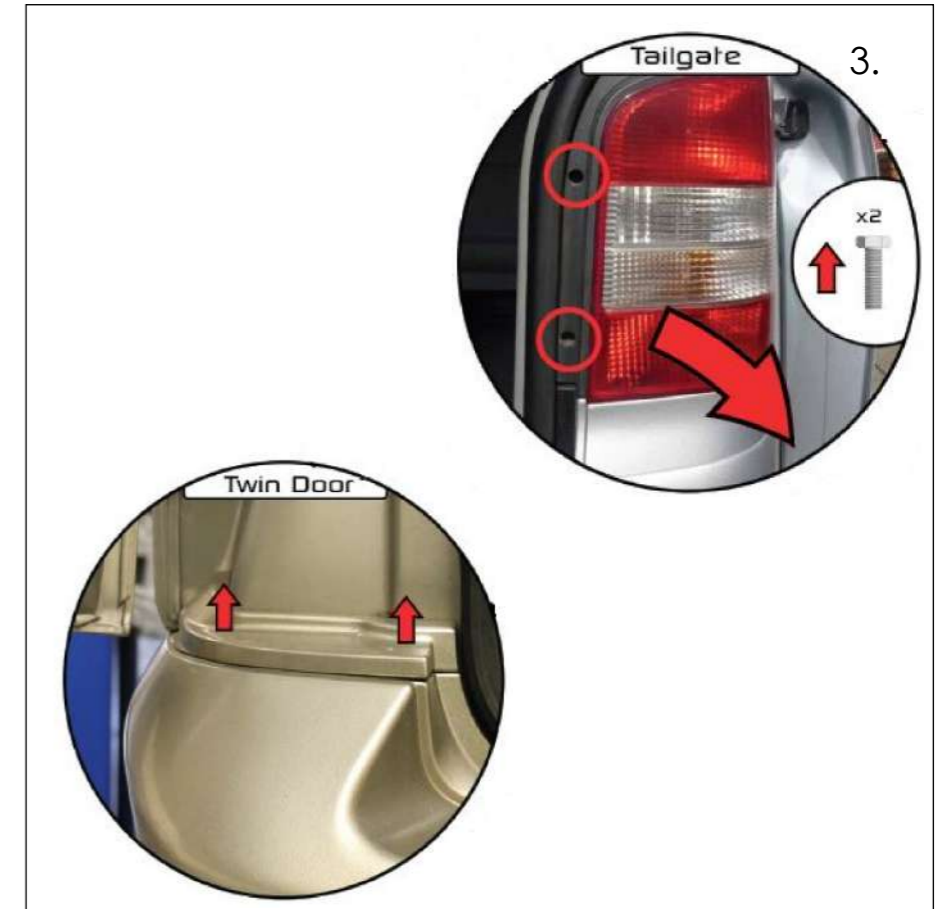
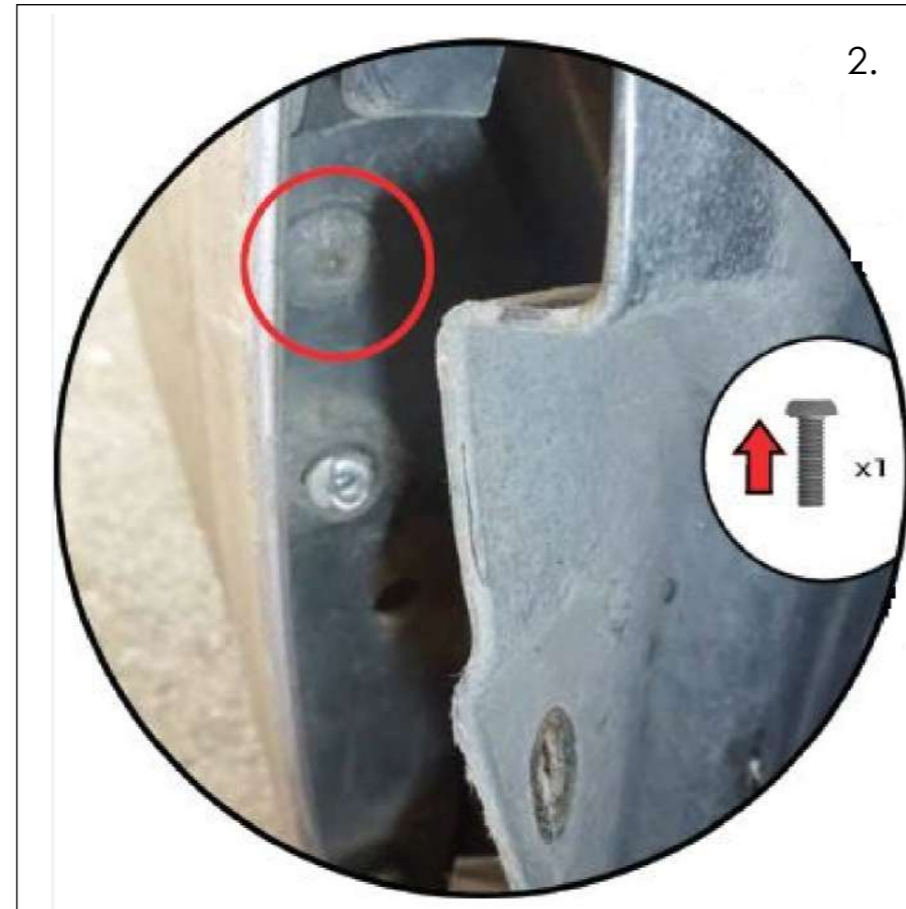
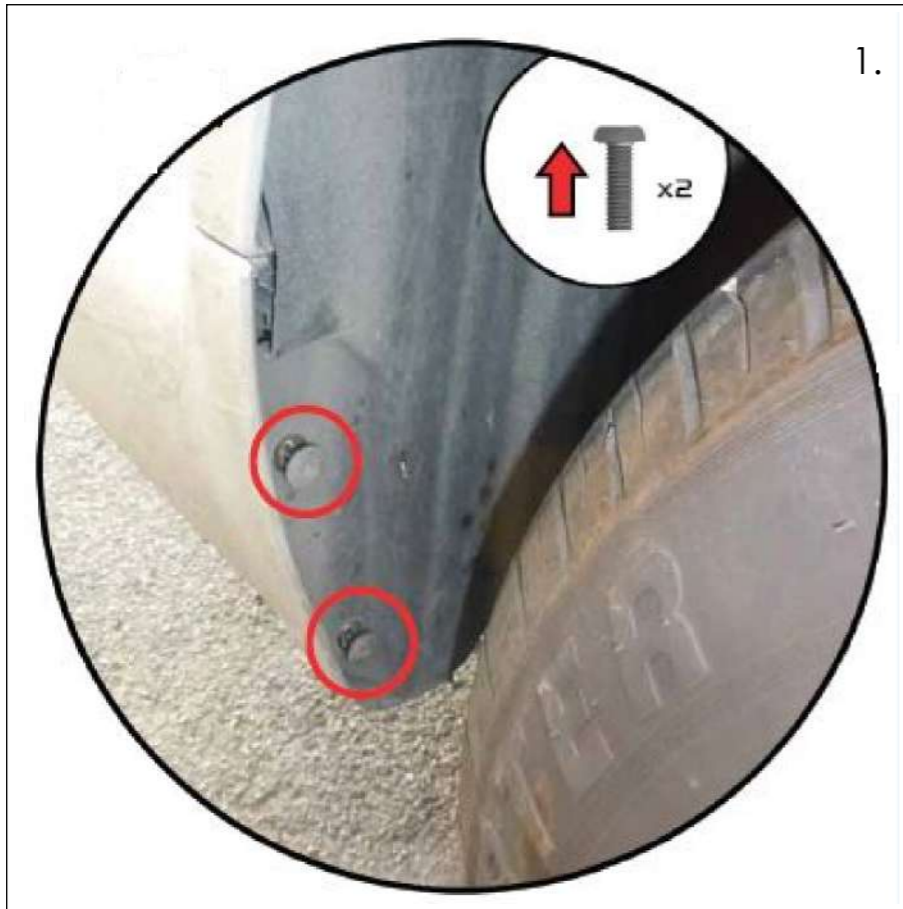

FITTING INSTRUCTIONS

7.



8.



9.



10.



FITTING INSTRUCTIONS

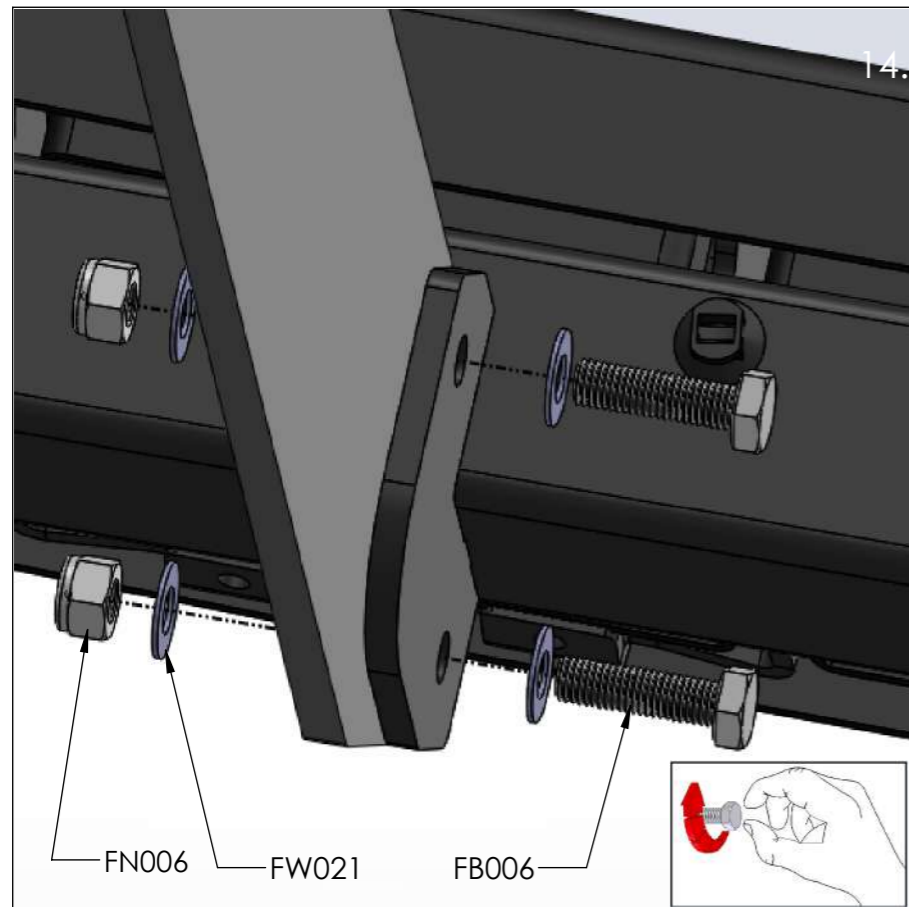

FITTING INSTRUCTIONS

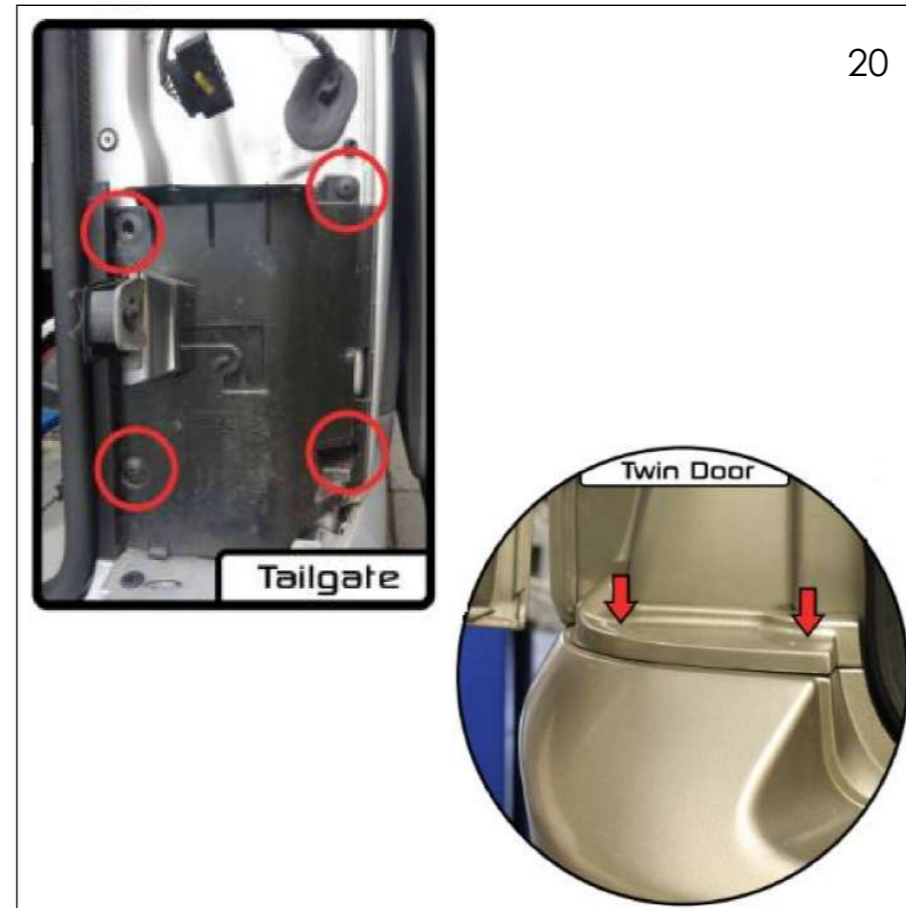
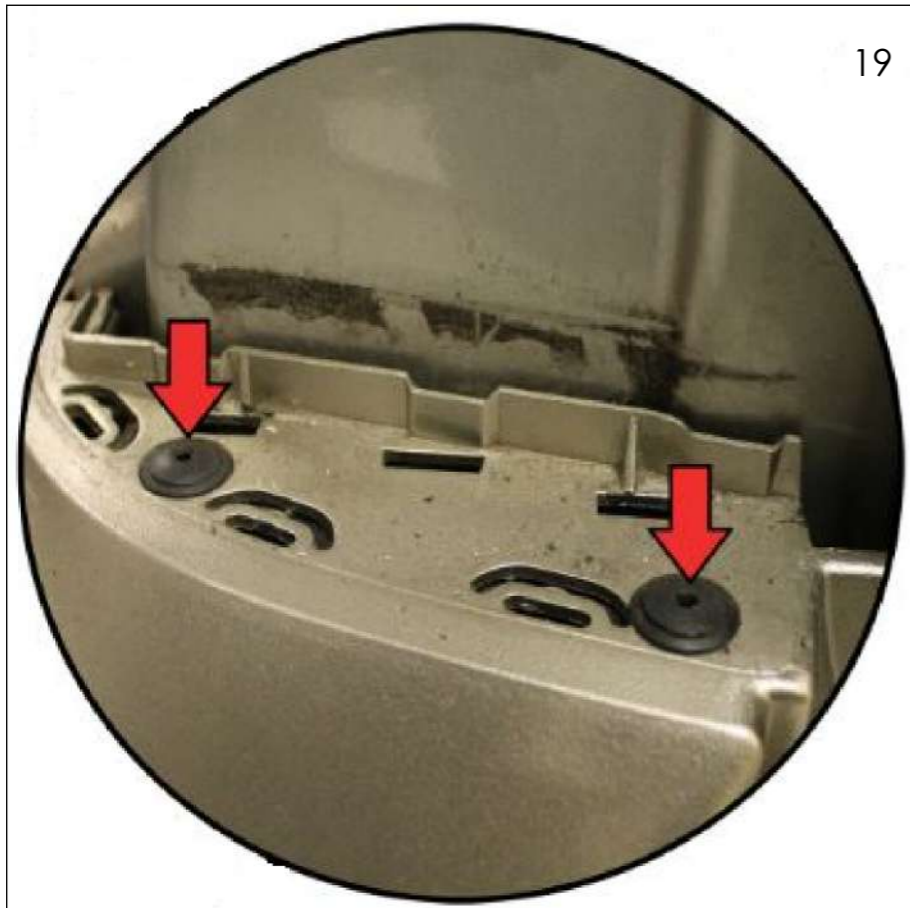
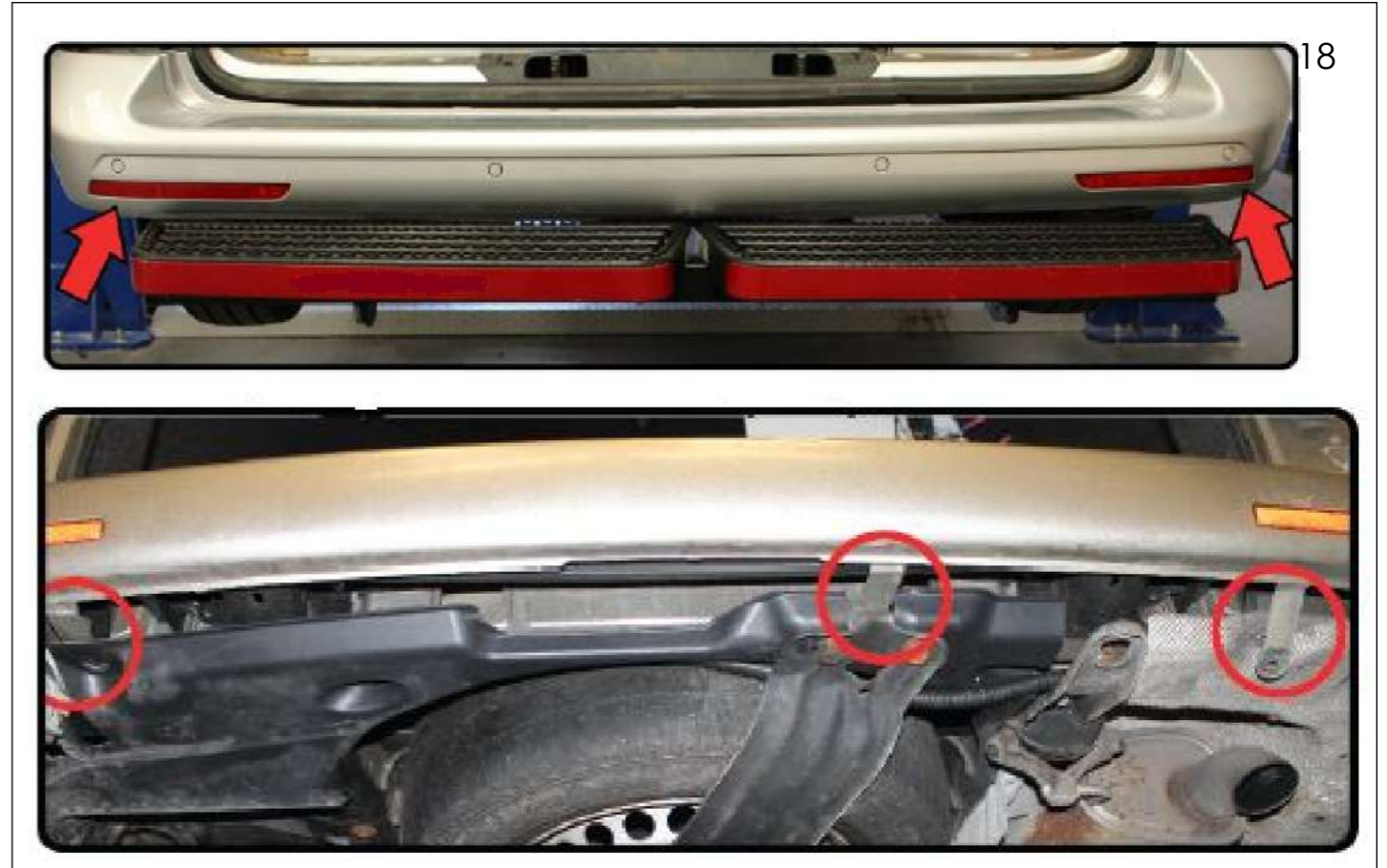
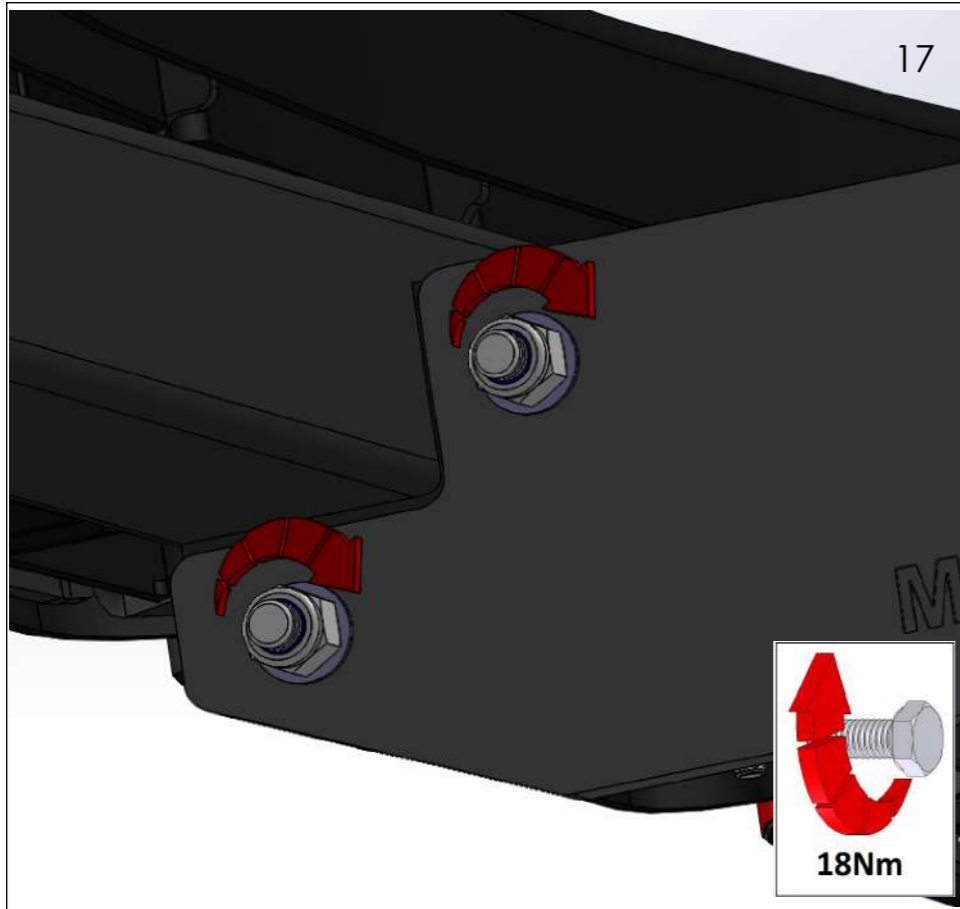

FITTING INSTRUCTIONS

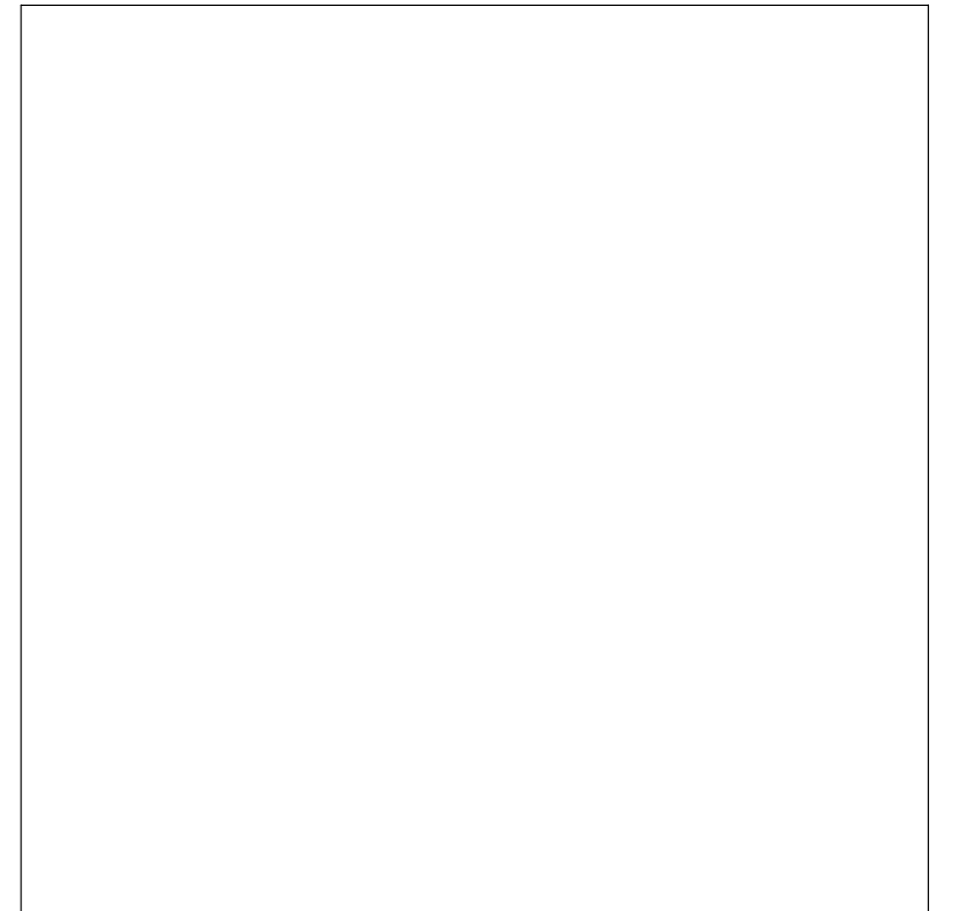
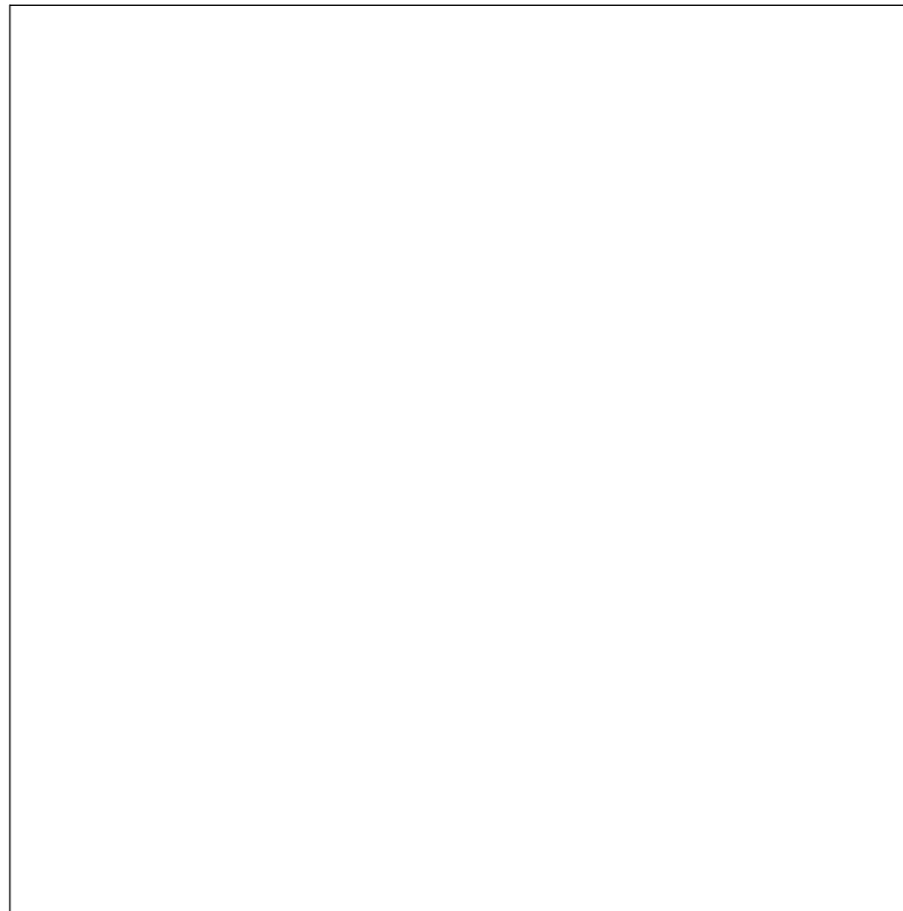
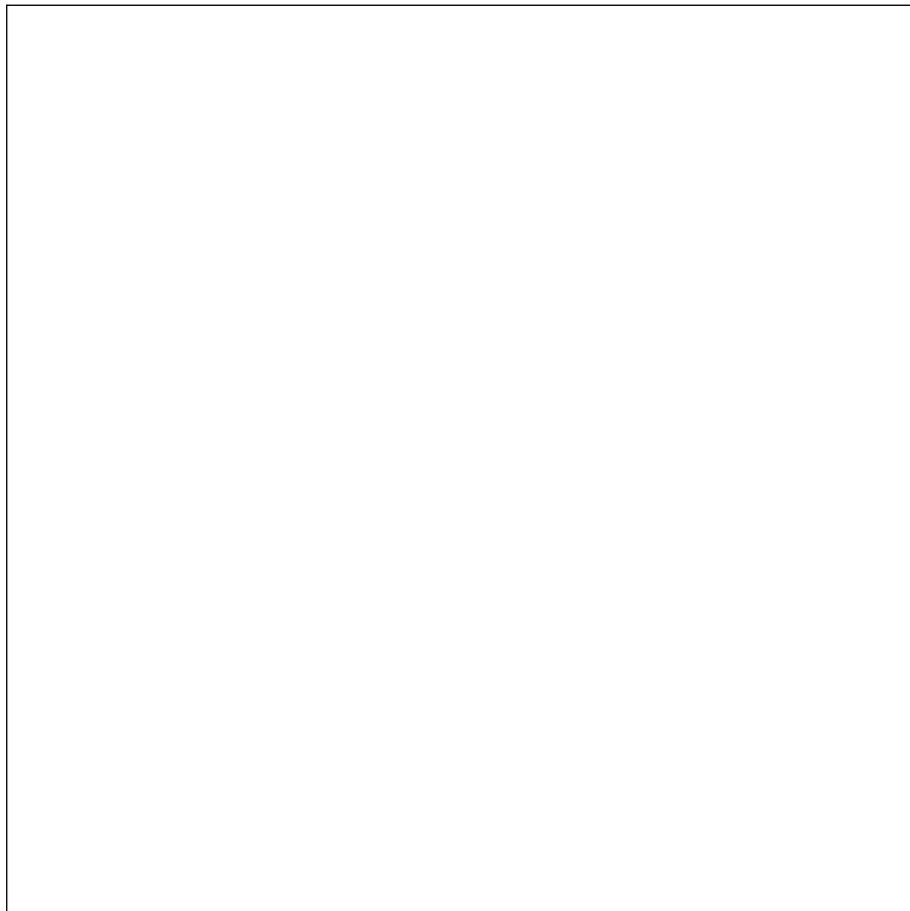
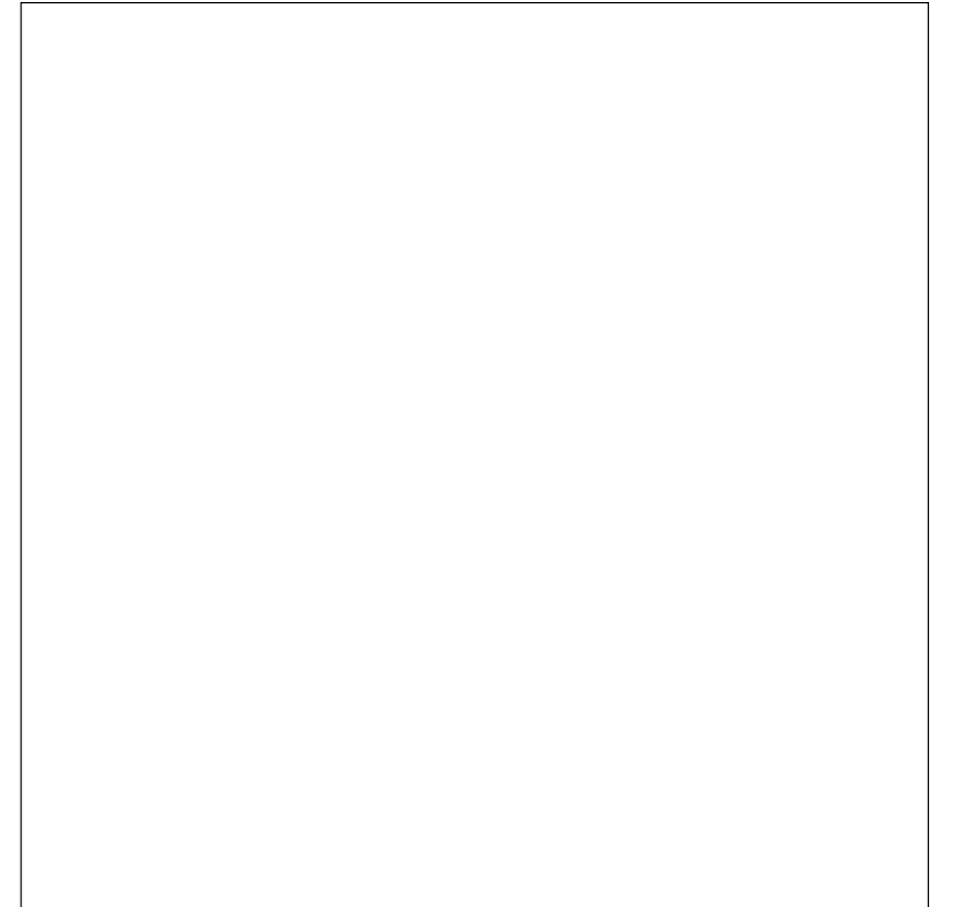
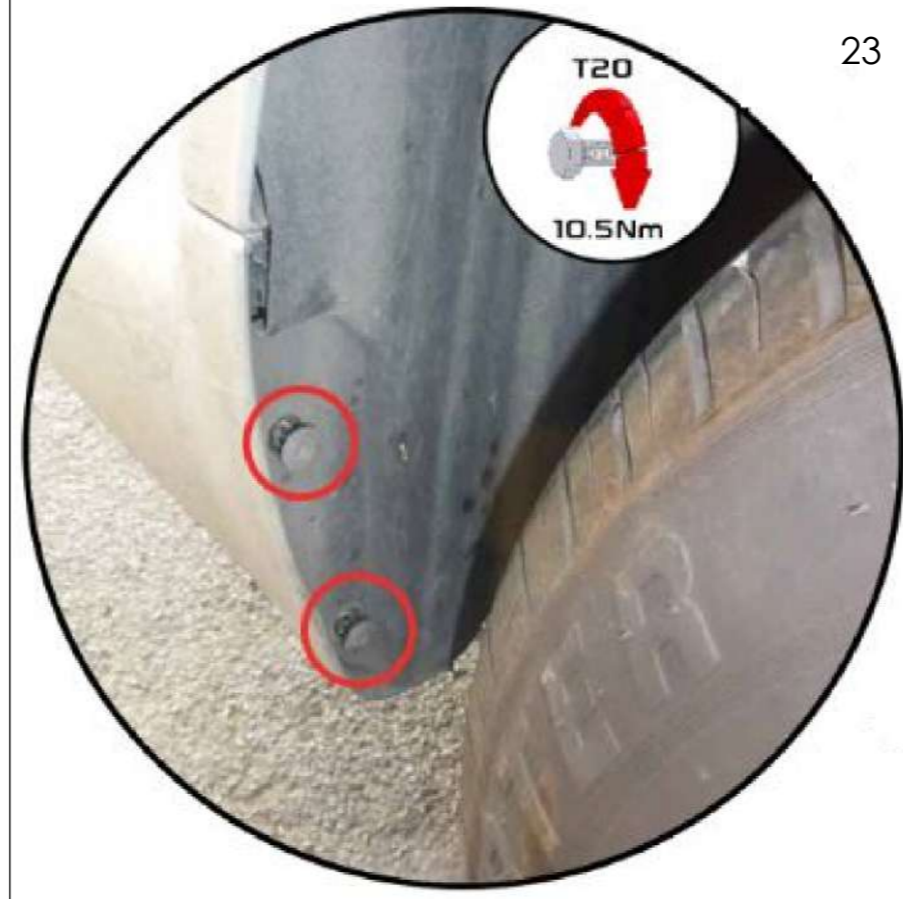
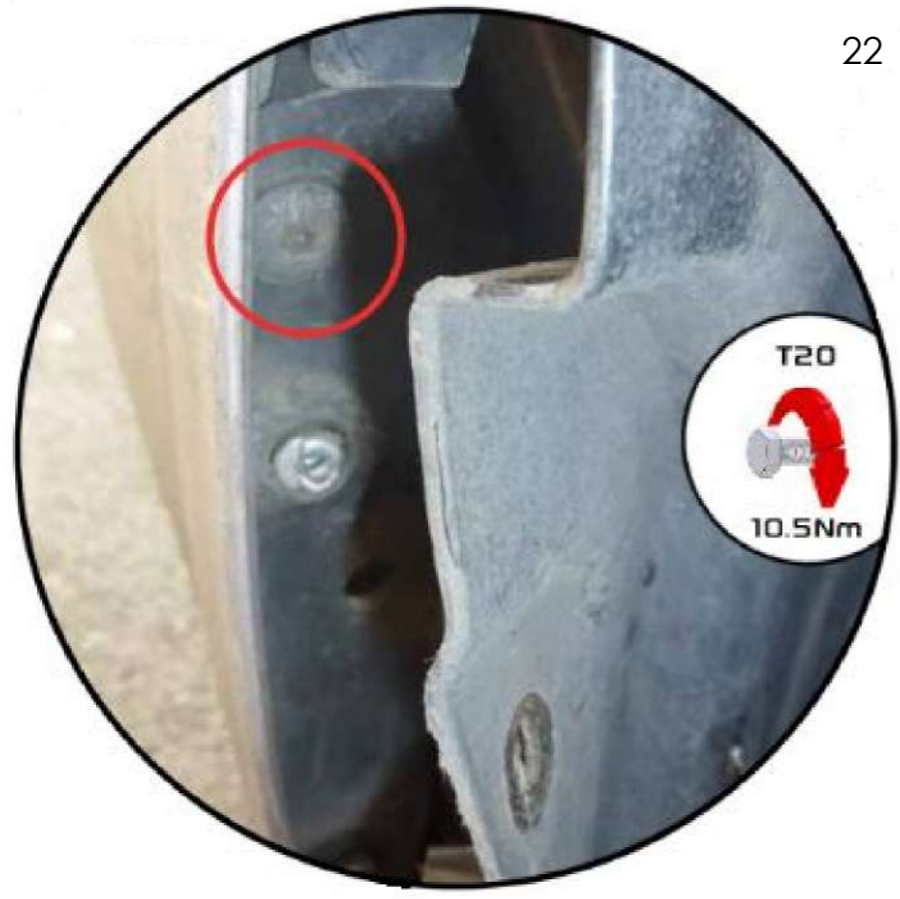

IMPACT STEP FITTING INSTRUCTIONS



Some vehicles may require VW parts:

1 x Plastic Rail (7H0 807 723)

8 x Gasket (357 853 586 B)

8 x Clip (701 867 299)

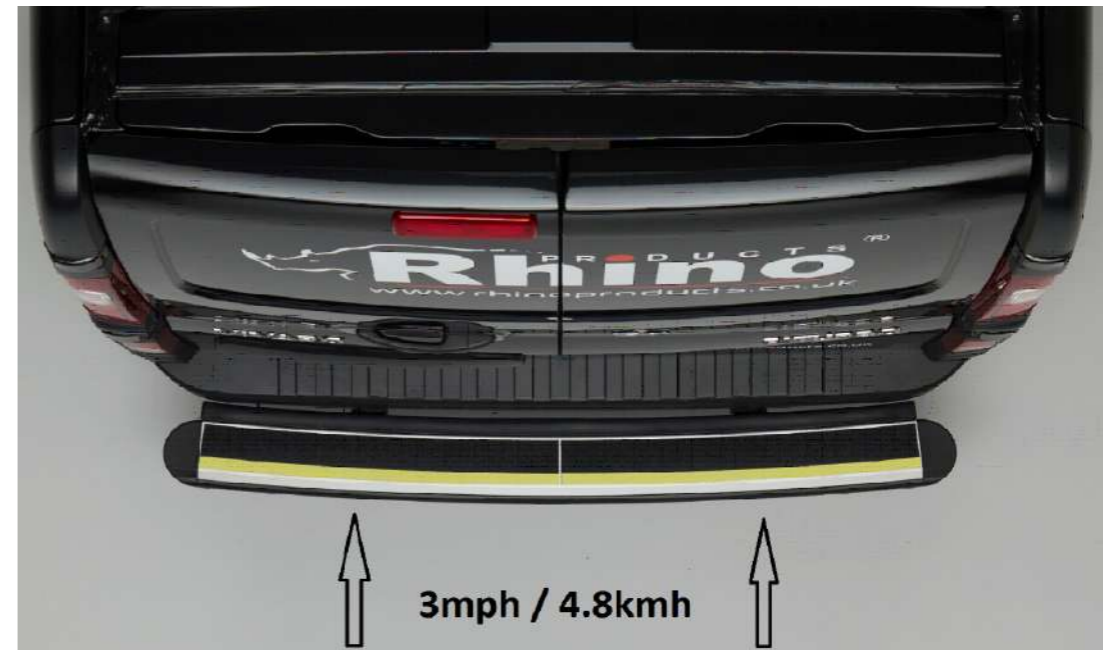
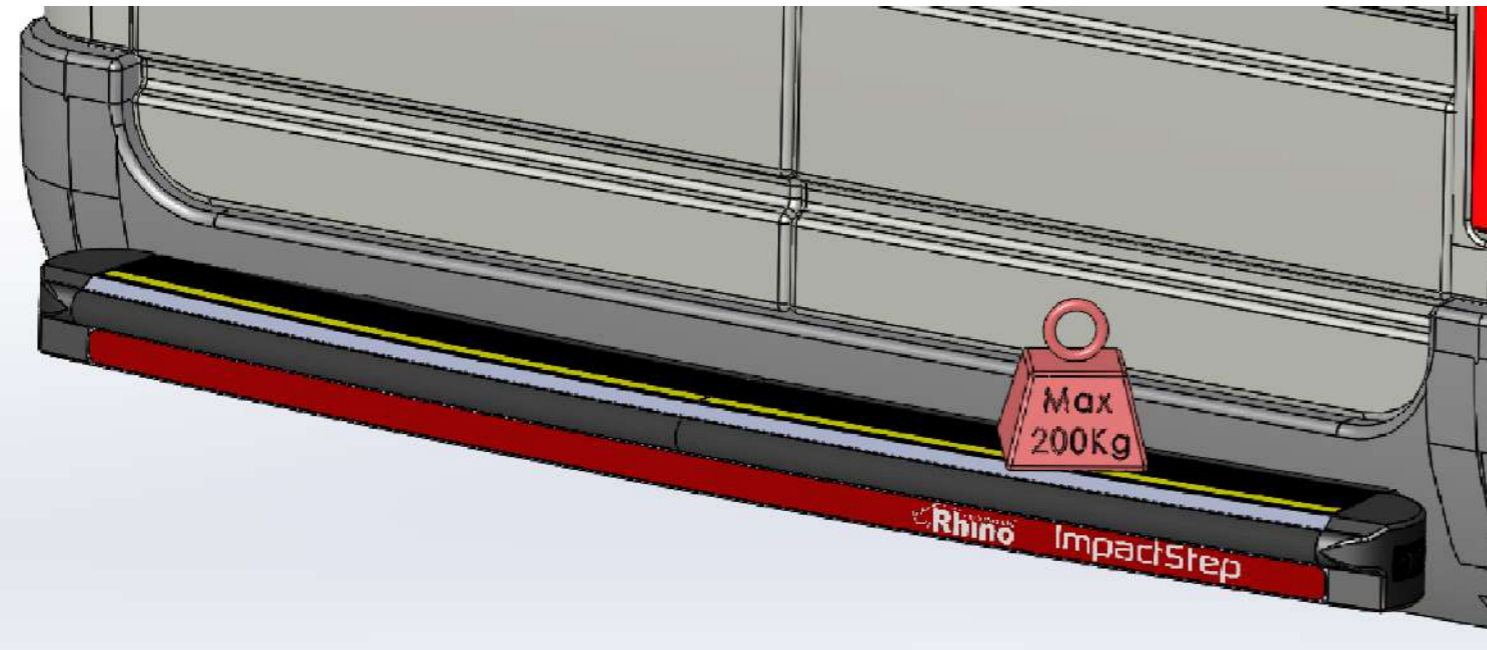

IMPACT STEP FITTING INSTRUCTIONS

FITTING KIT CONTENTS FK899
(1:1)

1



FW020 (M8) x 4

SAFESTEP	✗
IMPACT STEP	✓



FS066 (M8) x 4



FB006 (M8) x 4

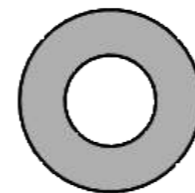

FW021 (M8) x

SAFESTEP	8
IMPACT STEP	4



FN006 (M8) x 4

SAFESTEP	✓
IMPACT STEP	✗

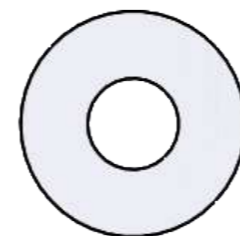

FW002 (M8) x 4

FITTING TIME: 60 Minutes

2

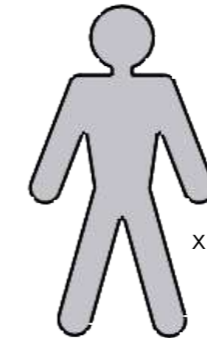

x1

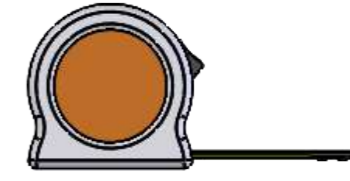

x1

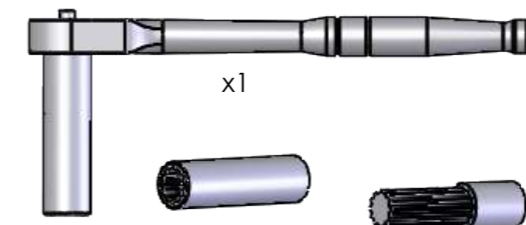

x1



13mm



T20 Torx



13mm x 1

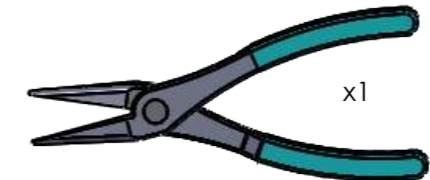

x1



x1



Clip remover x 1

IMPACT STEP FITTING INSTRUCTIONS

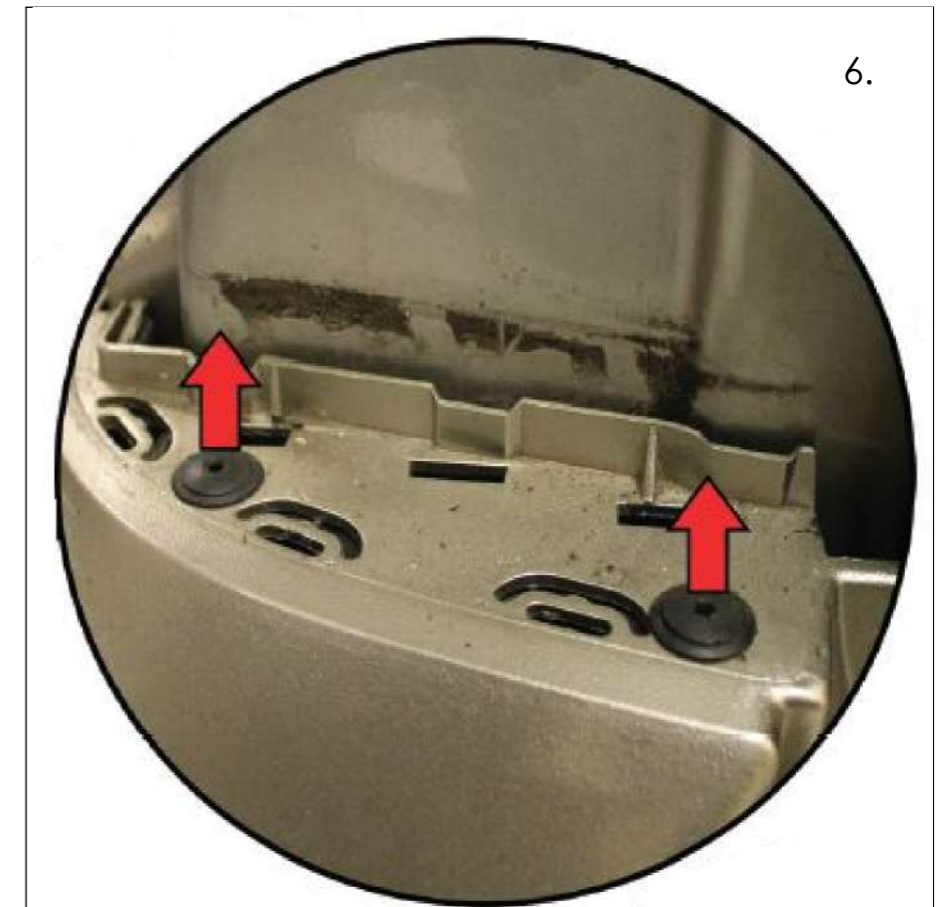
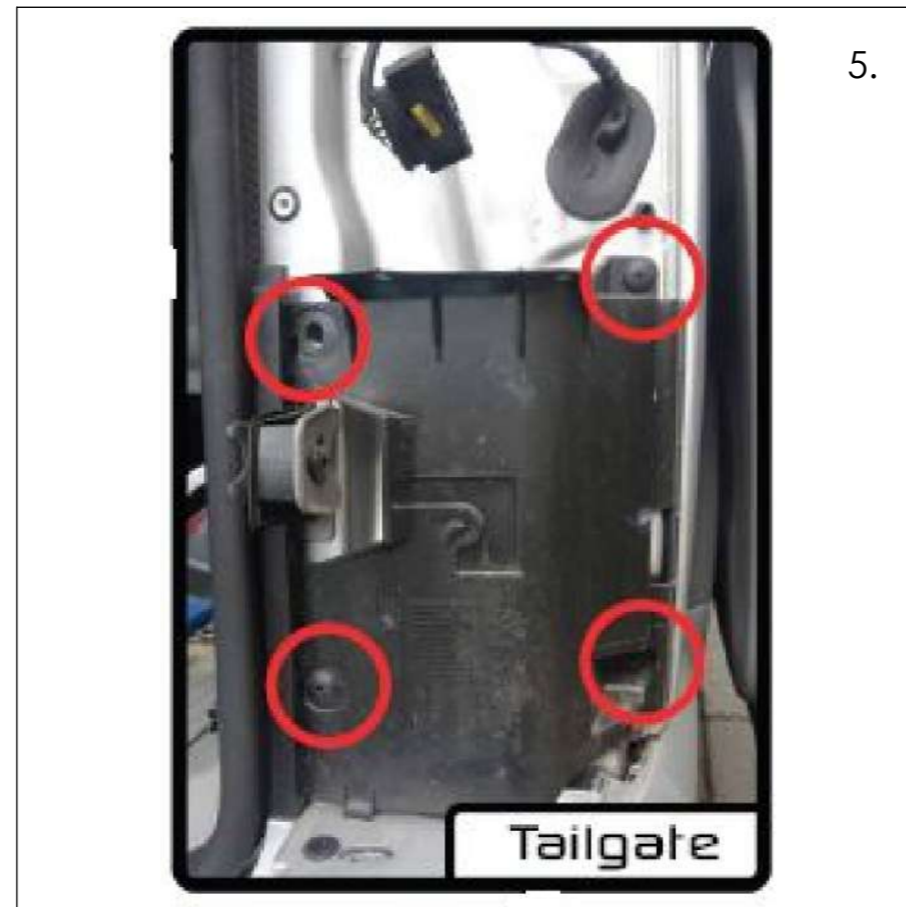
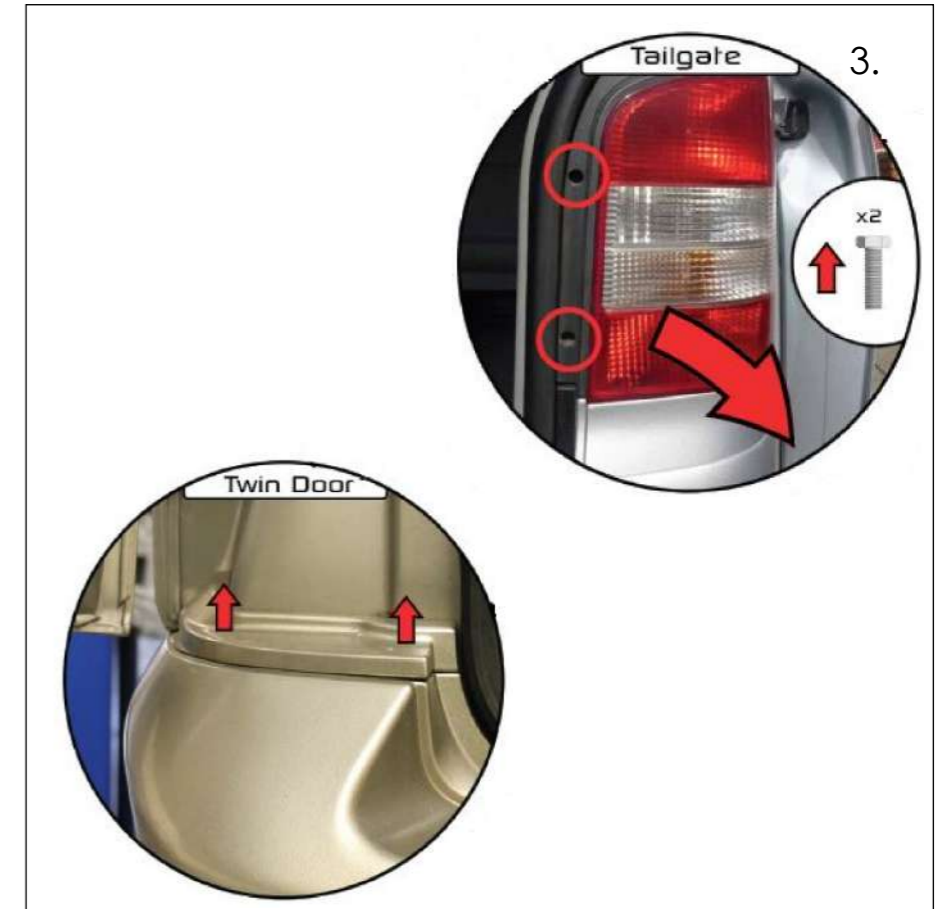
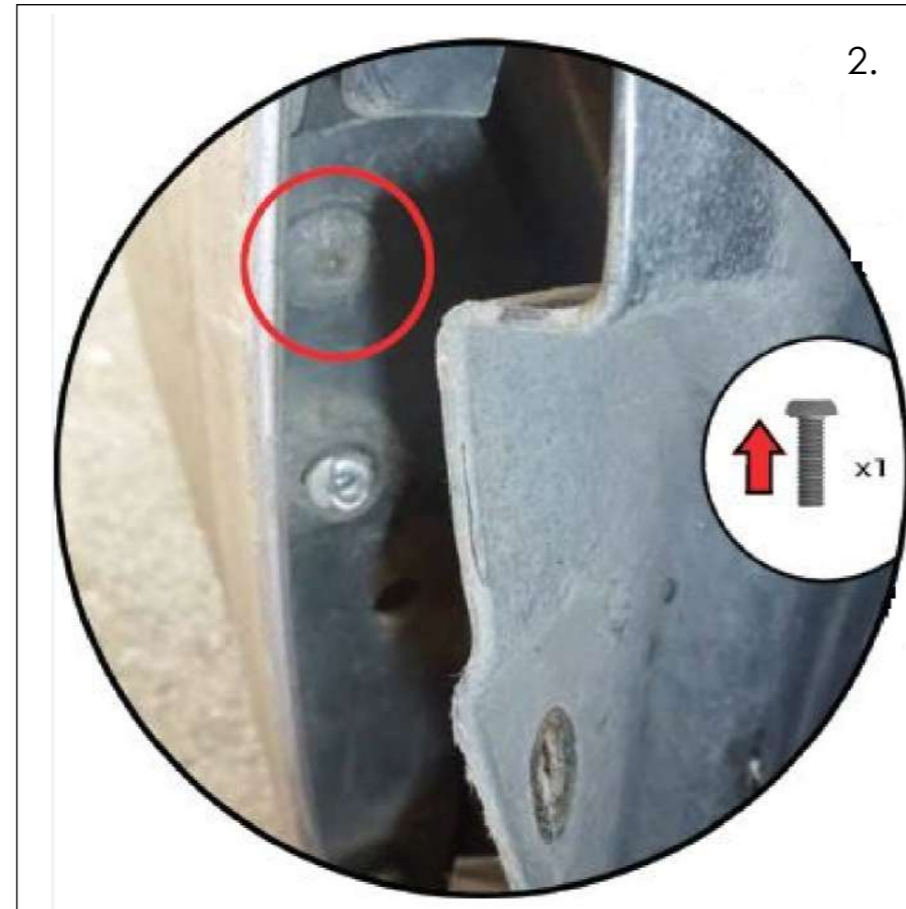
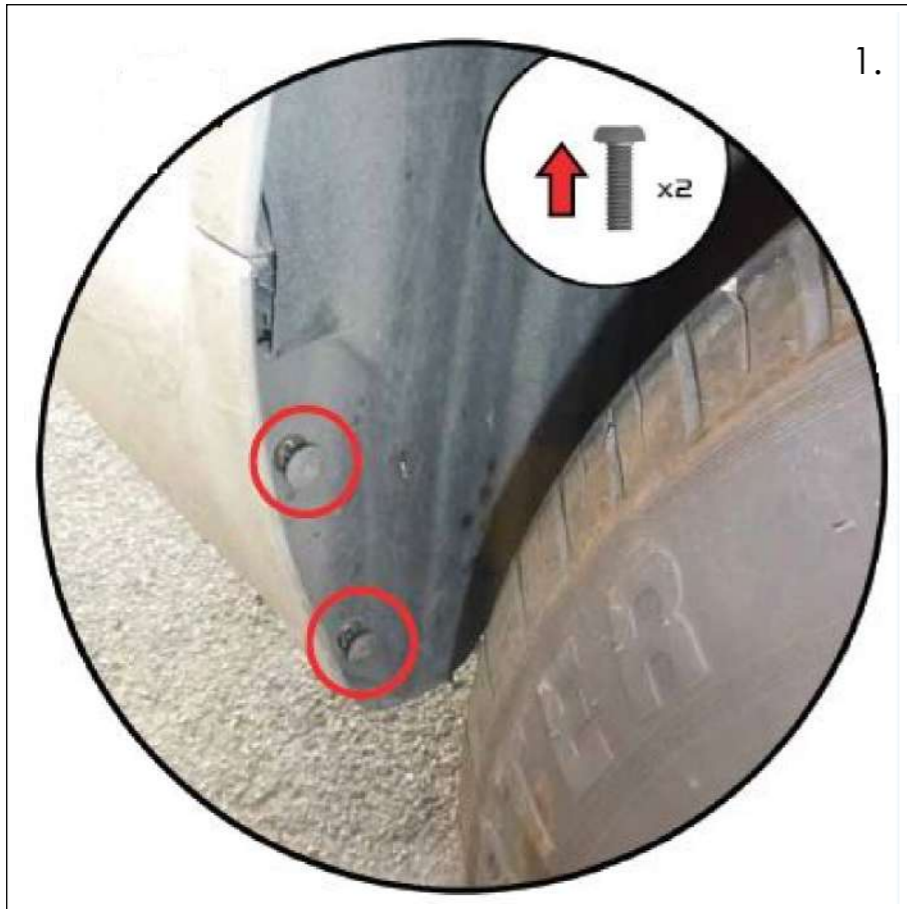

IMPACT STEP FITTING INSTRUCTIONS

7.



8



9.



10.



IMPACT STEP FITTING INSTRUCTIONS

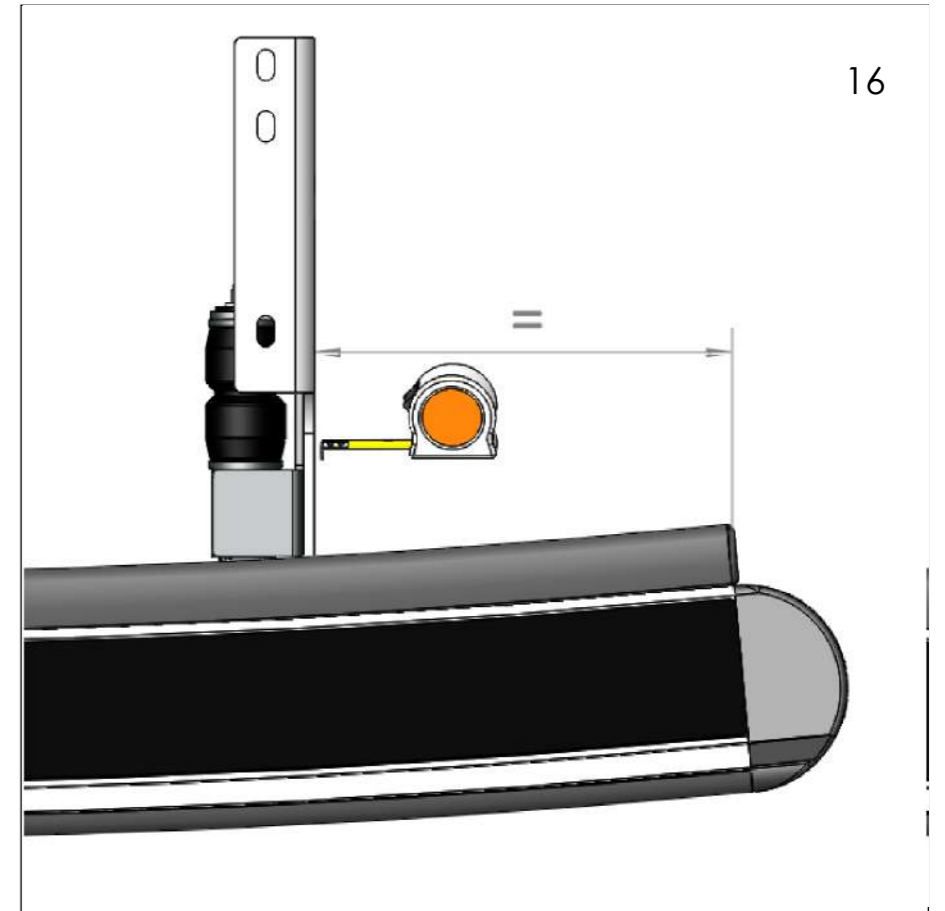
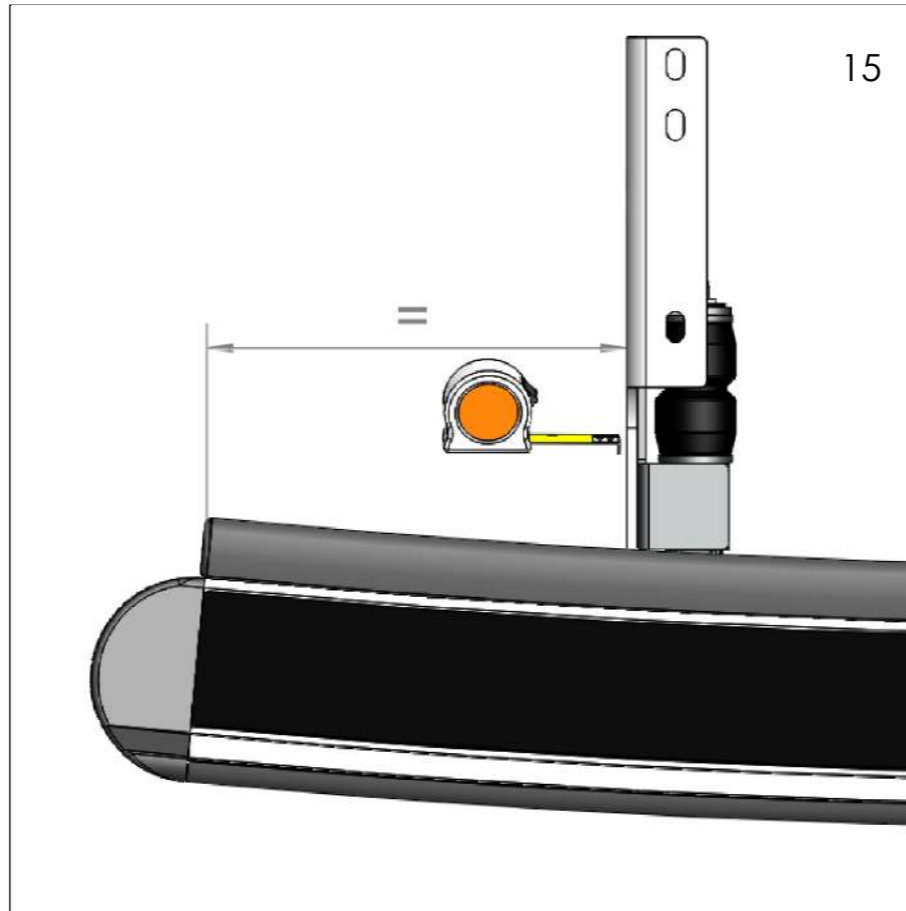
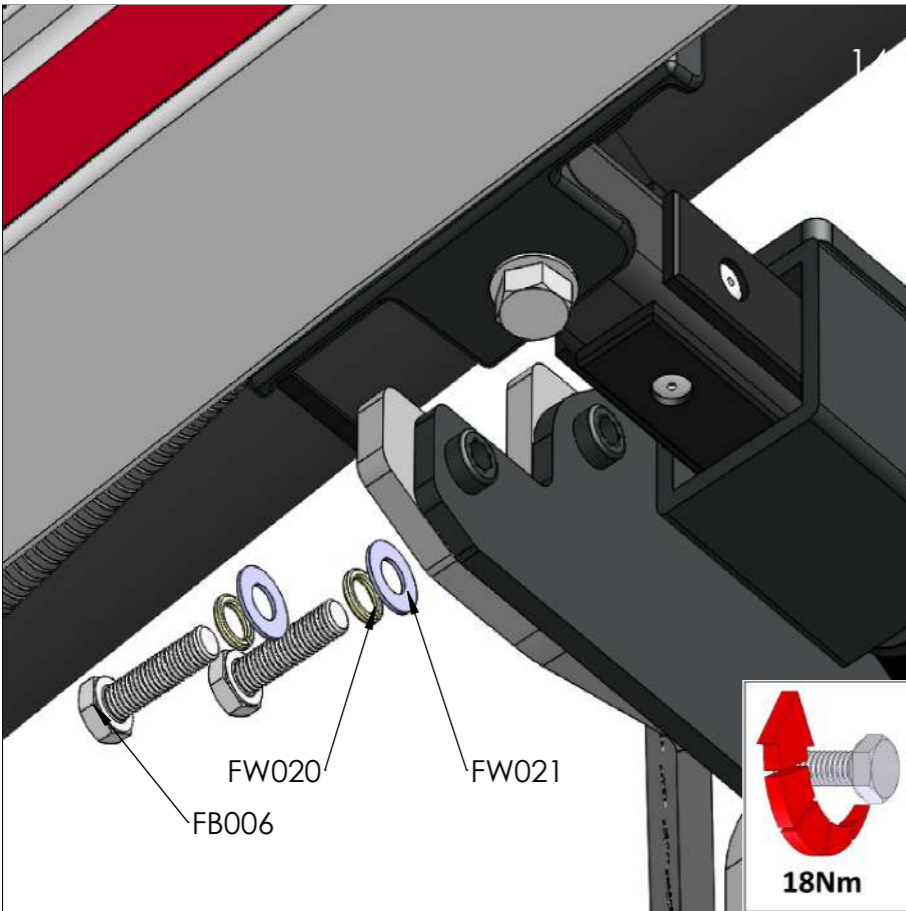
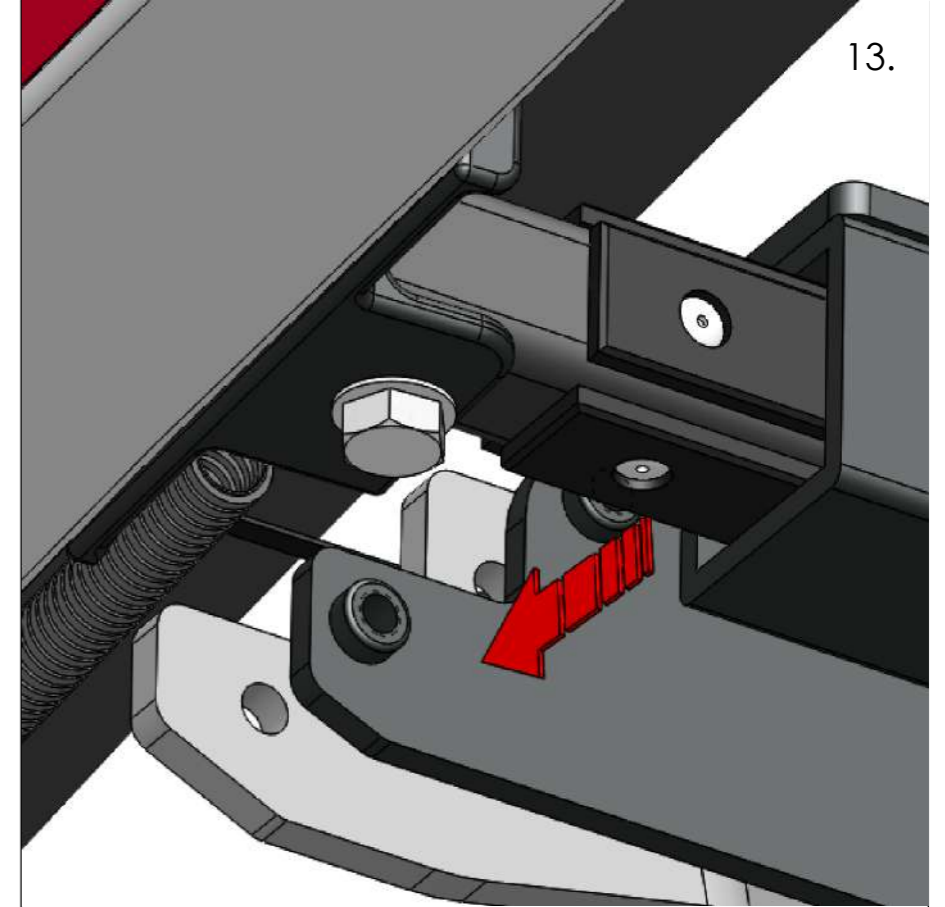

IMPACT STEP FITTING INSTRUCTIONS

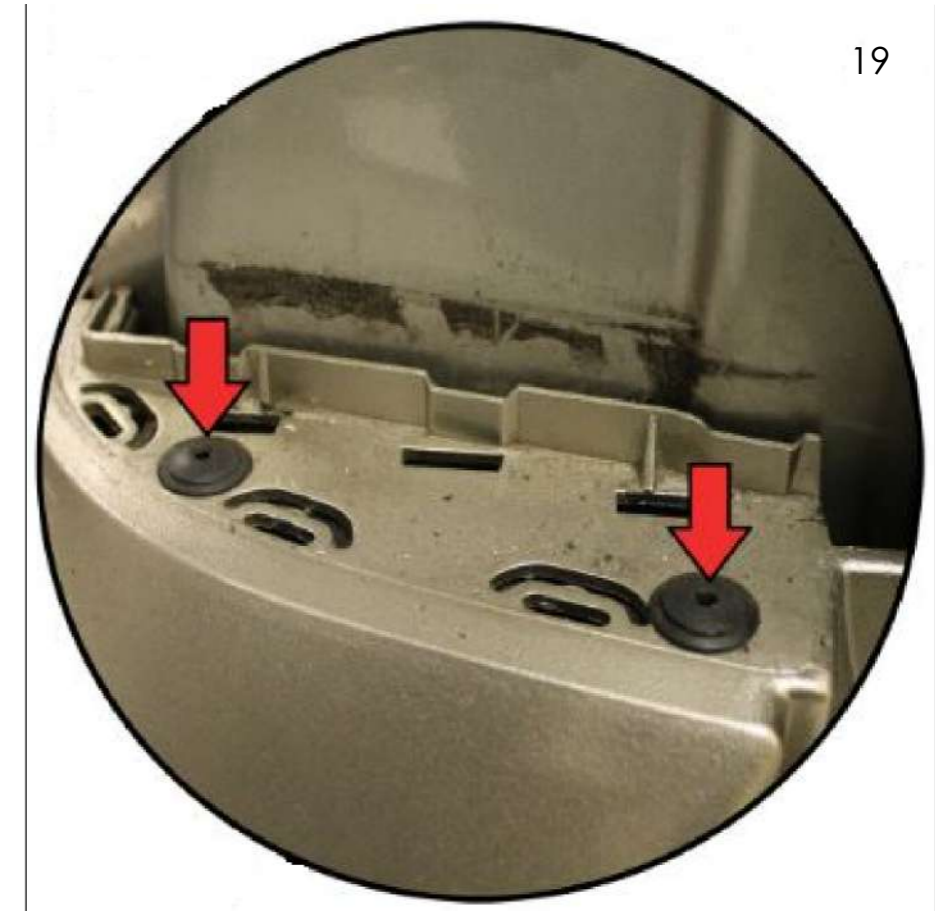
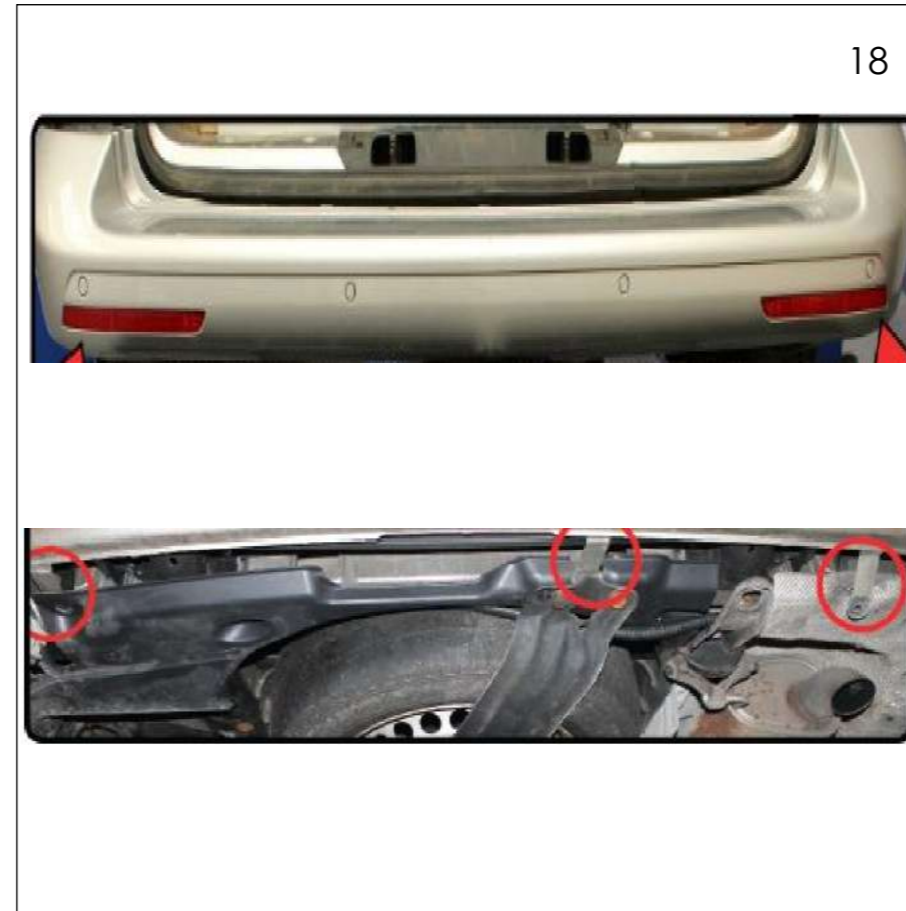
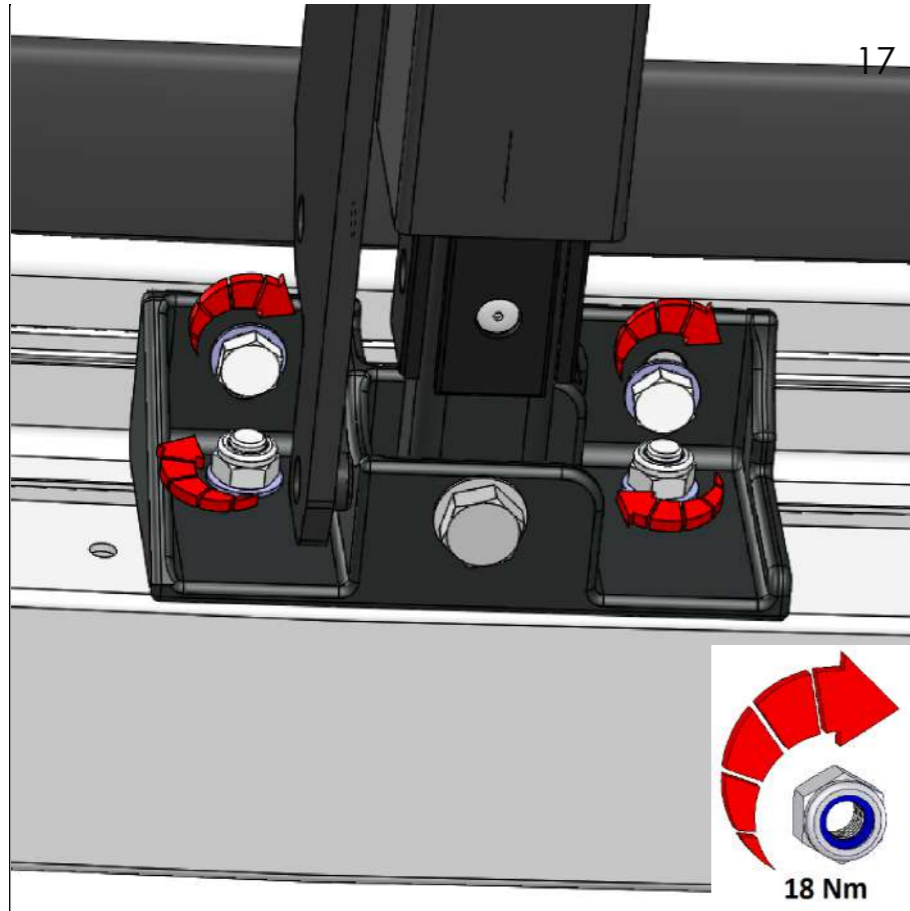

IMPACT STEP FITTING INSTRUCTIONS

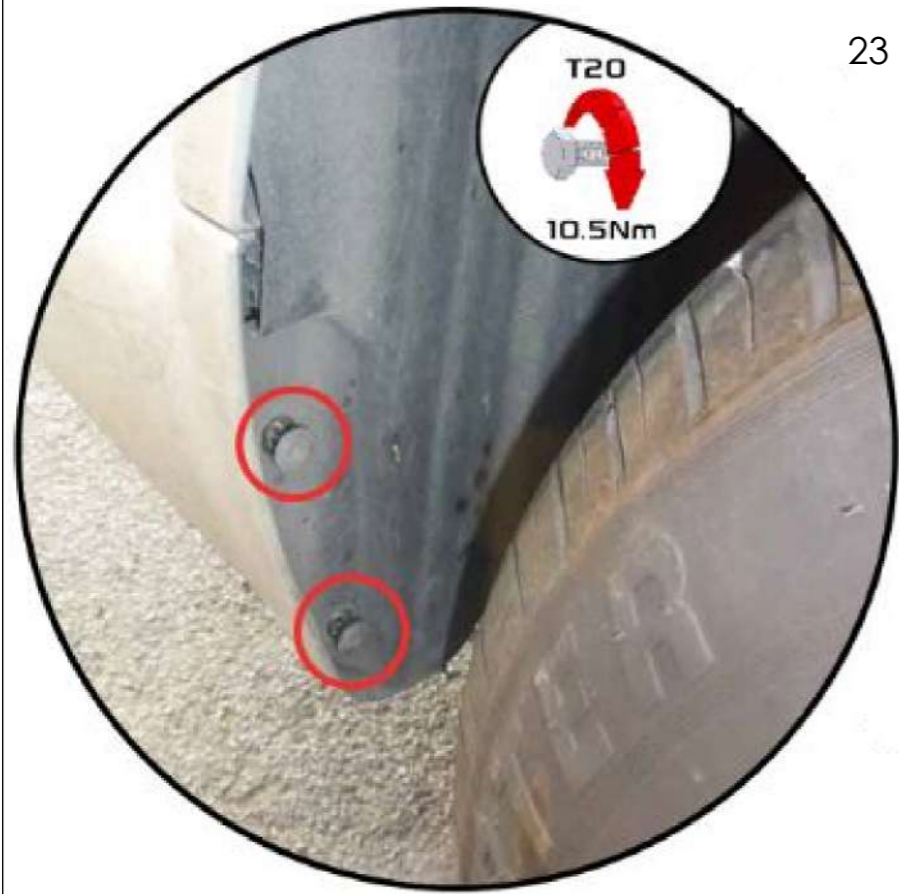

23

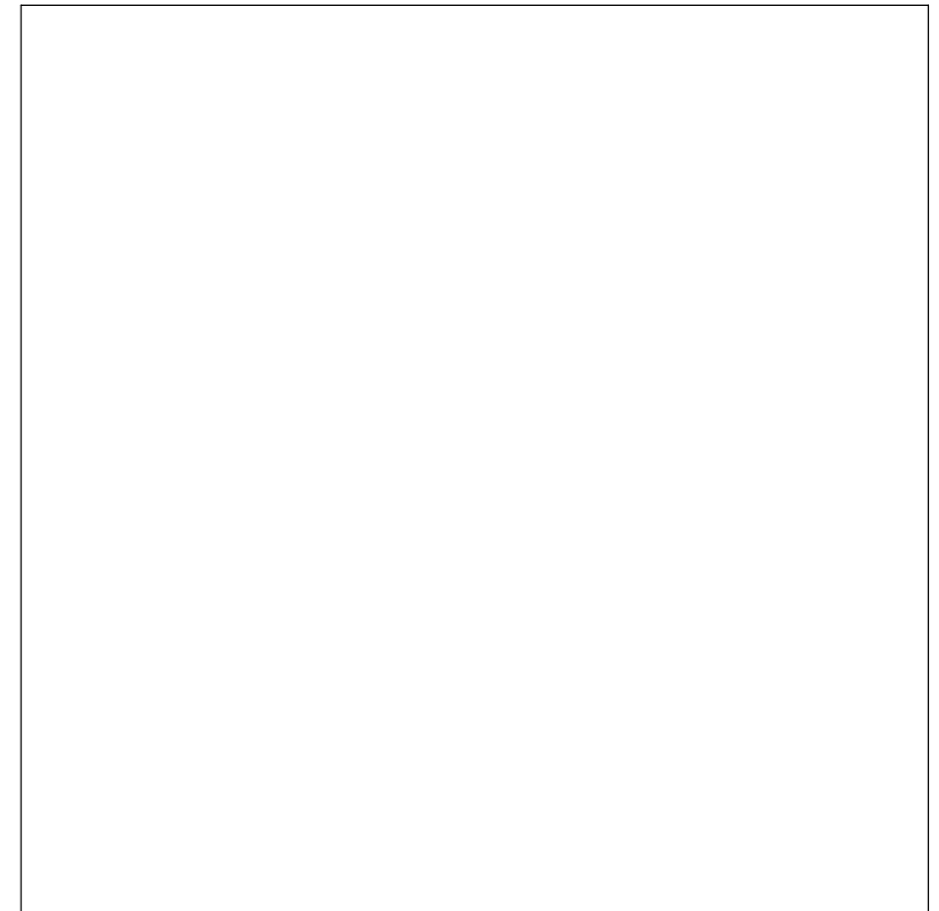
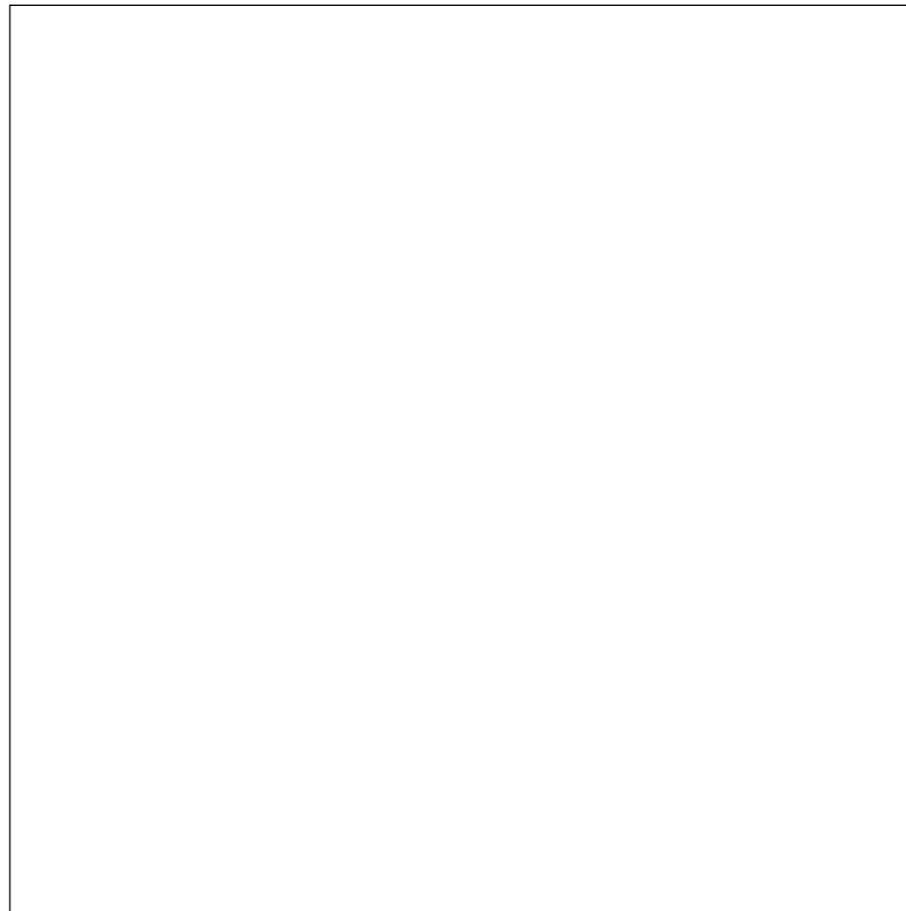
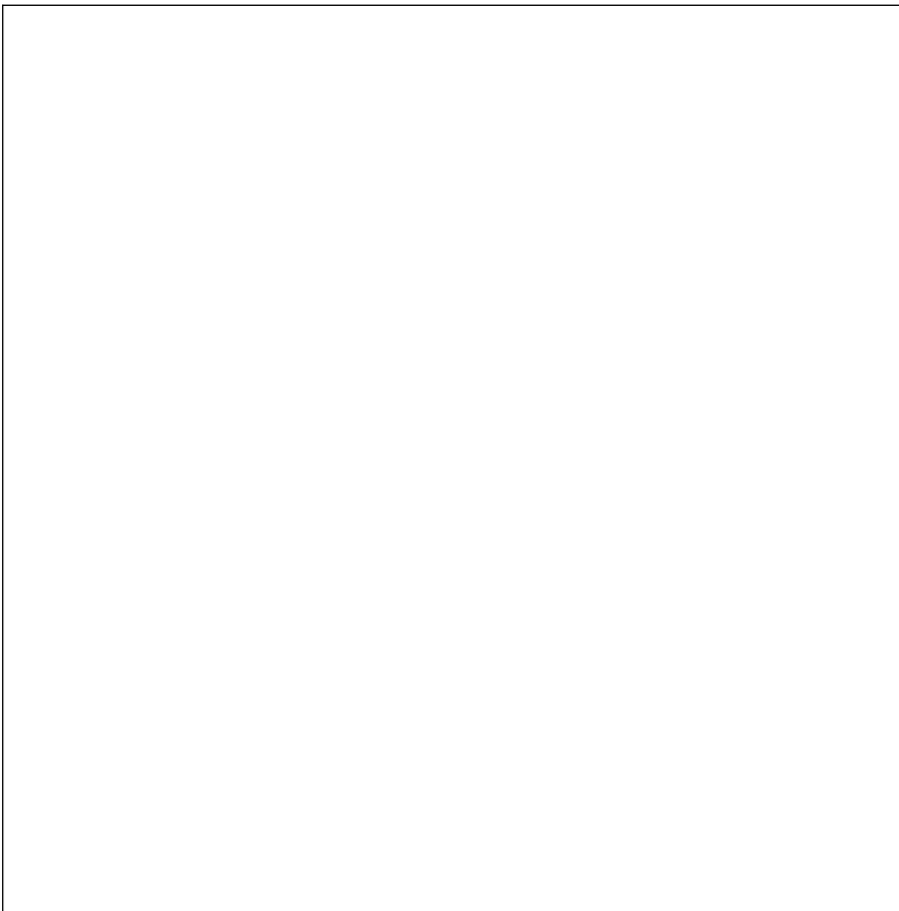
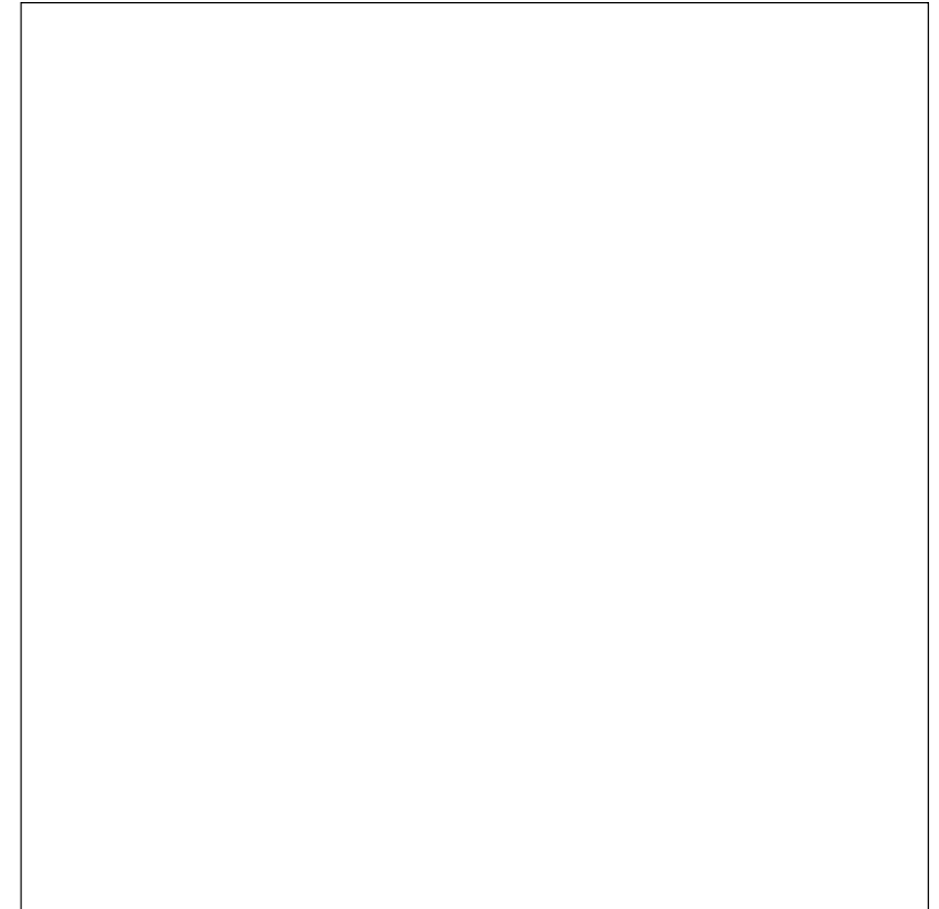
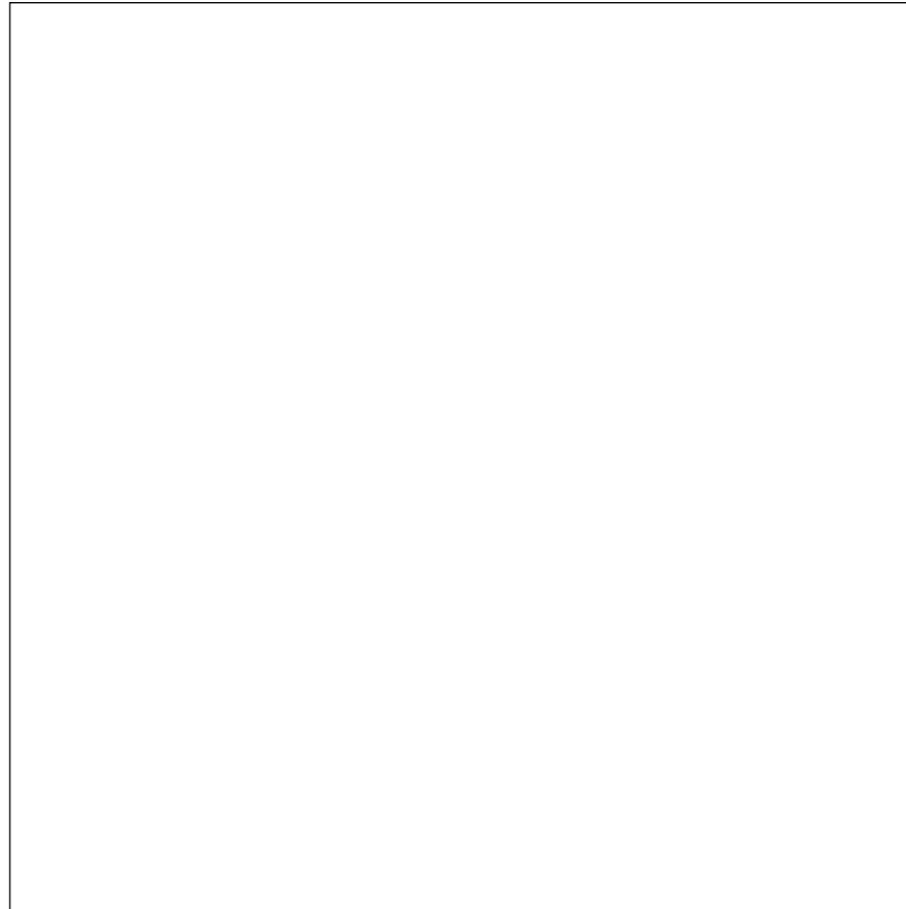



Rhino PRODUCTS[®]

SafeStep[™] **connect**⁺



GB: **Important!** The assembly instructions **MUST** be followed to ensure correct operation. Failure to do so can result in invalidated warranty and could affect operation.

FR: **Important!** Vous **DEVEZ IMPÉRATIVEMENT** suivre ces instructions d'assemblage pour assurer un fonctionnement correct du produit. Le non-respect de ces instructions peut entraîner une annulation de la garantie et entraver le bon fonctionnement.

ES: **¡Importante!** Estas instrucciones de montaje **DEBEN** ser seguidas para asegurar el correcto funcionamiento. De no hacerlo, puede resultar inválida la garantía y puede afectar el funcionamiento.

DE: **Wichtiger Hinweis!** Um die fehlerfreie Funktion sicherzustellen, **MUSS** diese Montageanleitung befolgt werden. Andernfalls kann die Garantie erlöschen und die Funktion beeinträchtigt werden.

NL: **Belangrijk!** **VOLG** deze inbouw instructies nauwgezet, zodat het systeem correct functioneert. Onjuiste installatie kan resulteren in een beperking van de werking en tevens de garantie.

IT: **Importante!** **È NECESSARIO** seguire le presenti istruzioni per il montaggio per garantire un corretto funzionamento. In caso contrario, la garanzia potrebbe essere invalidata e il funzionamento potrebbe risentirne.

PL: **UWAGA!** Aby system działał poprawnie, należy postępować dokładnie według instrukcji montażu. Nieprzestrzeganie tego procesu, może wpłynąć na działanie czujników lub też doprowadzić do utraty gwarancji.

SE: **Viktigt!** Monteringsinstruktionerna måste följas noggrant för att säkerställa funktionen. Om så ej görs upphör dels garantin att gälla samt även att själva funktionen kan påverkas.

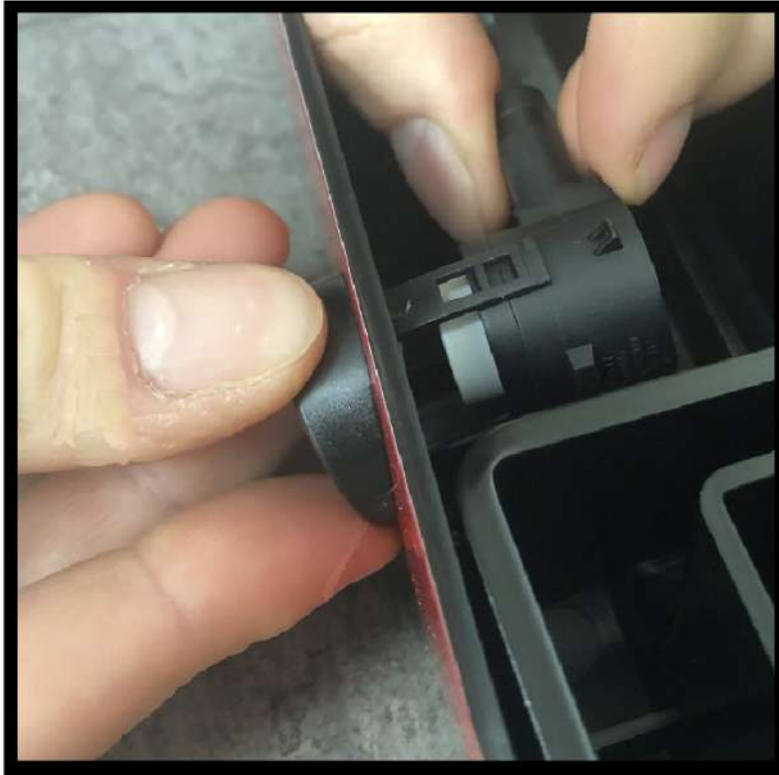

GB: **ALWAYS** support the sensor adapter from the outside while fitting the vehicle sensors.

FR: Toujours veiller à un bon support des adaptateurs du capteur lors du montage des capteurs du véhicule.

ES: Sujete siempre el adaptador de sensor mientras instale sensores de vehículos.

DE: Es ist darauf zu achten, dass der Sensoradapter beim Anbringen der Fahrzeugsensoren immer gestützt wird.

NL: Ondersteun de sensorhouders tijdens de installatie van de voertuigsensoren.

IT: Sostenere sempre l'adattatore del sensore durante l'installazione dei sensori del veicolo.

PL: Zawsze podtrzymuj adaptery podczas montażu czujników.

SW: Ge sensoradaptern stöd när fordonets sensorer monteras.



GB: **DO NOT** over bend the adapter arms when inserting the vehicle sensors.

FR: Ne pas courber les bras de l'adaptateur lors de l'insertion des capteurs.

ES: No doble demasiado los brazos de los adaptadores cuando inserte sensores.

DE: Die Adapterarme beim Einsetzen der Sensoren nicht überbiegen.

NL: Buig de sensorhouder-armen niet te ver naar buiten

IT: Non piegare eccessivamente i bracci dell'adattatore durante l'inserimento dei sensori.

PL: Podczas wkładania czujników parkowania do adapterów, należy pamiętać, aby nadmiernie nie zginać ramion adaptera.

SW: öj ej adapterns armar för mycket när sensorer monteras.

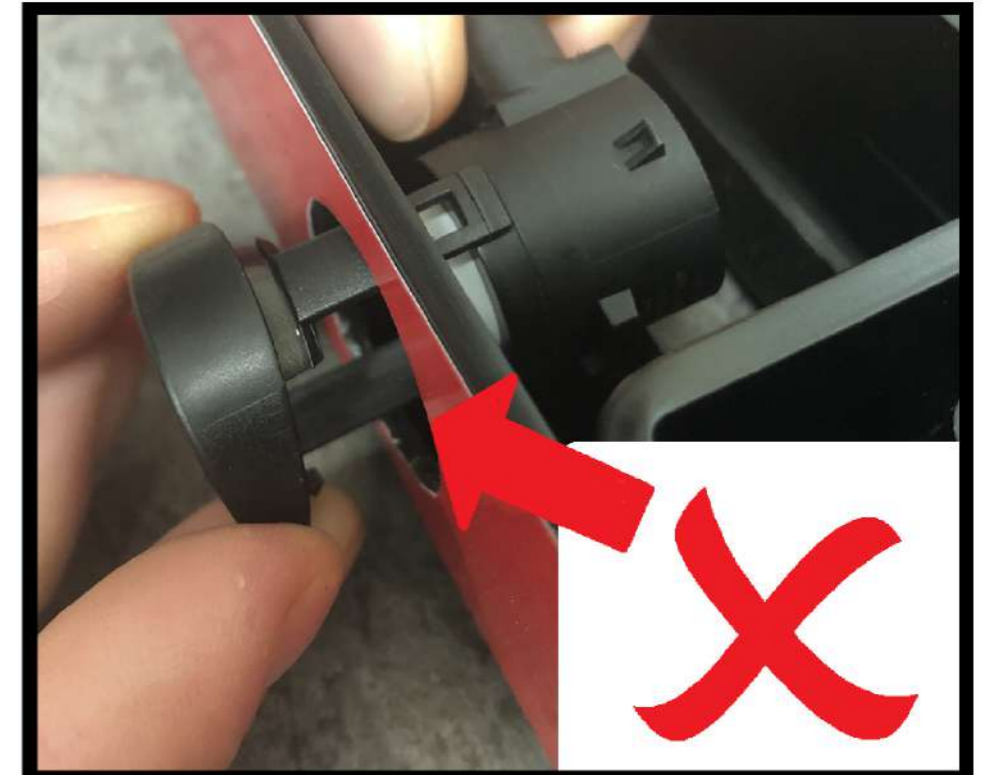

GB: **DO NOT** de-mount the adapters from the step when fitting the sensors

FR: Veillez à ne pas démonter les adaptateurs du marchepied lors du montage des capteurs.

ES: Tenga cuidado en no desmontar adaptadores del escalón cuando instale sensores.

DE: Darauf achten, dass beim Anbringen der Sensoren keine Adapter von der Trittstufe abmontiert werden.

NL: Zorg ervoor dat de sensorhouders niet uit de opstap worden gedrukt, tijdens de installatie van de sensors.







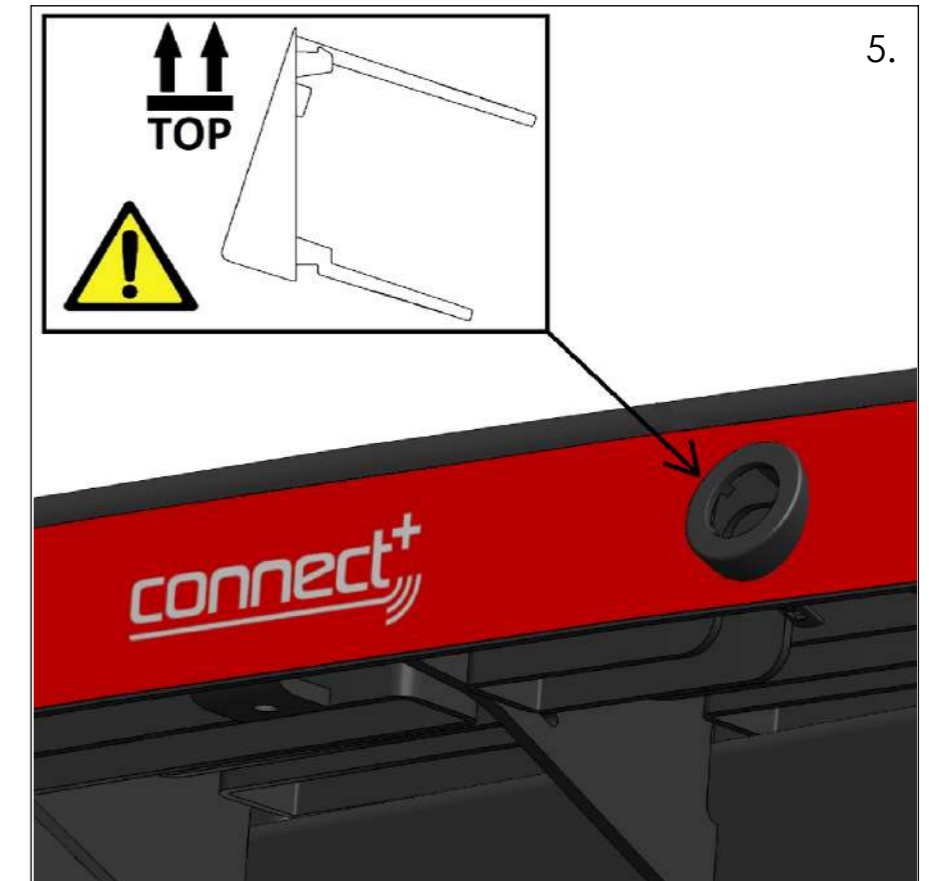
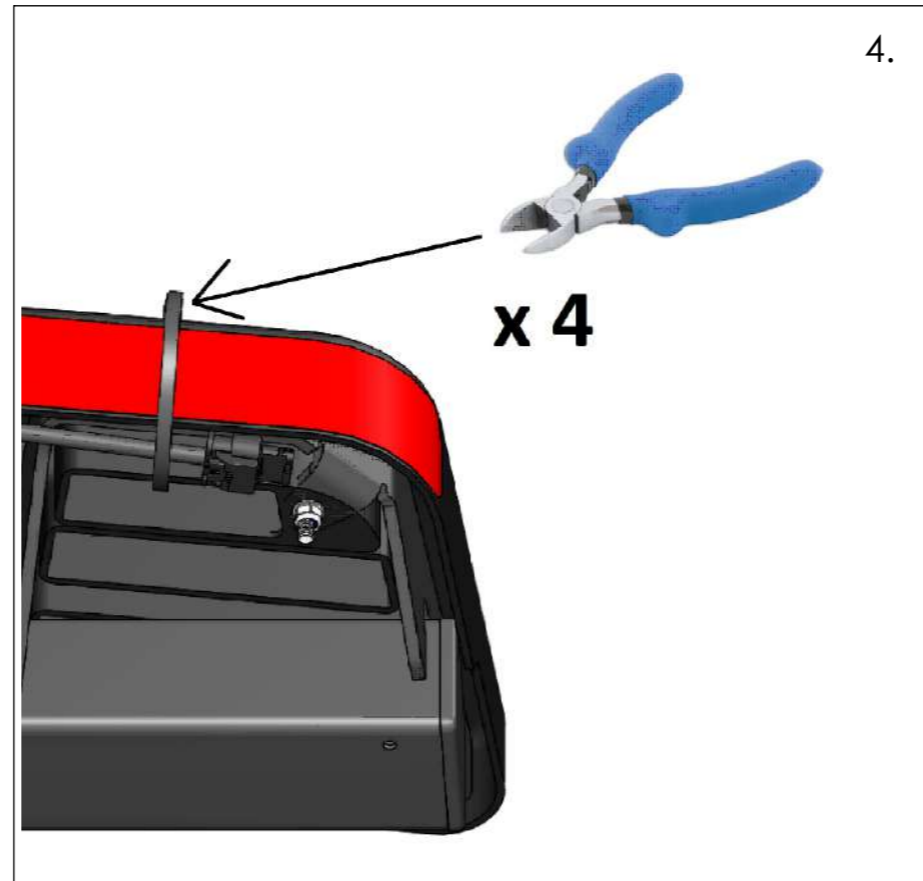
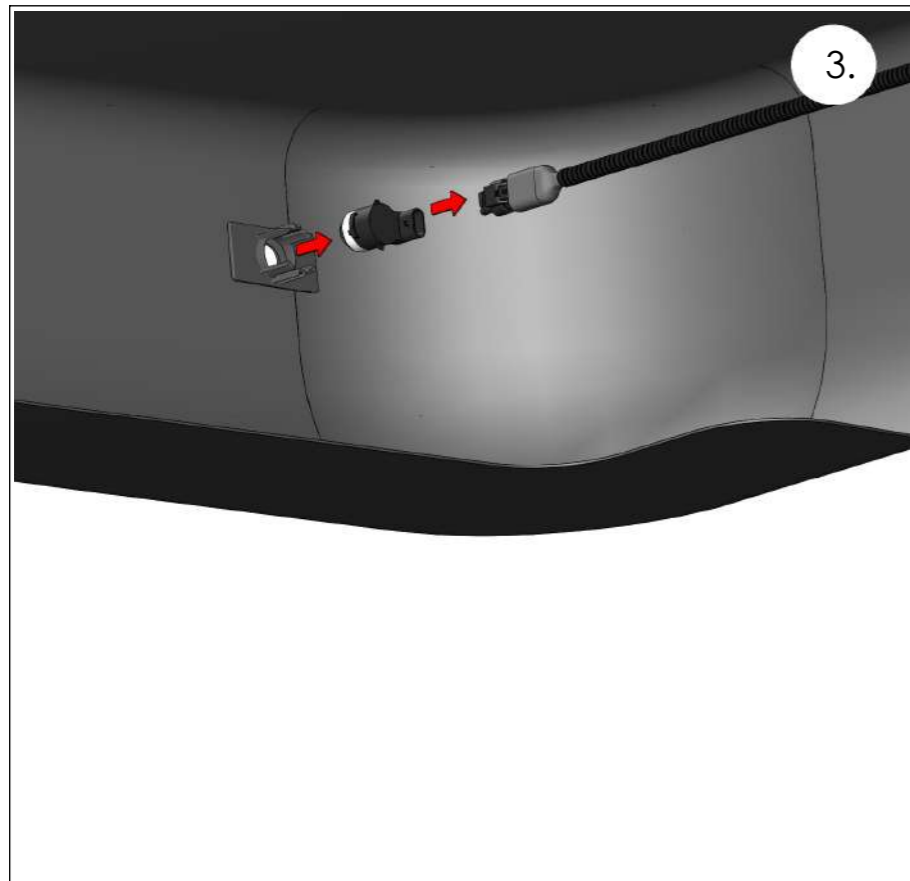
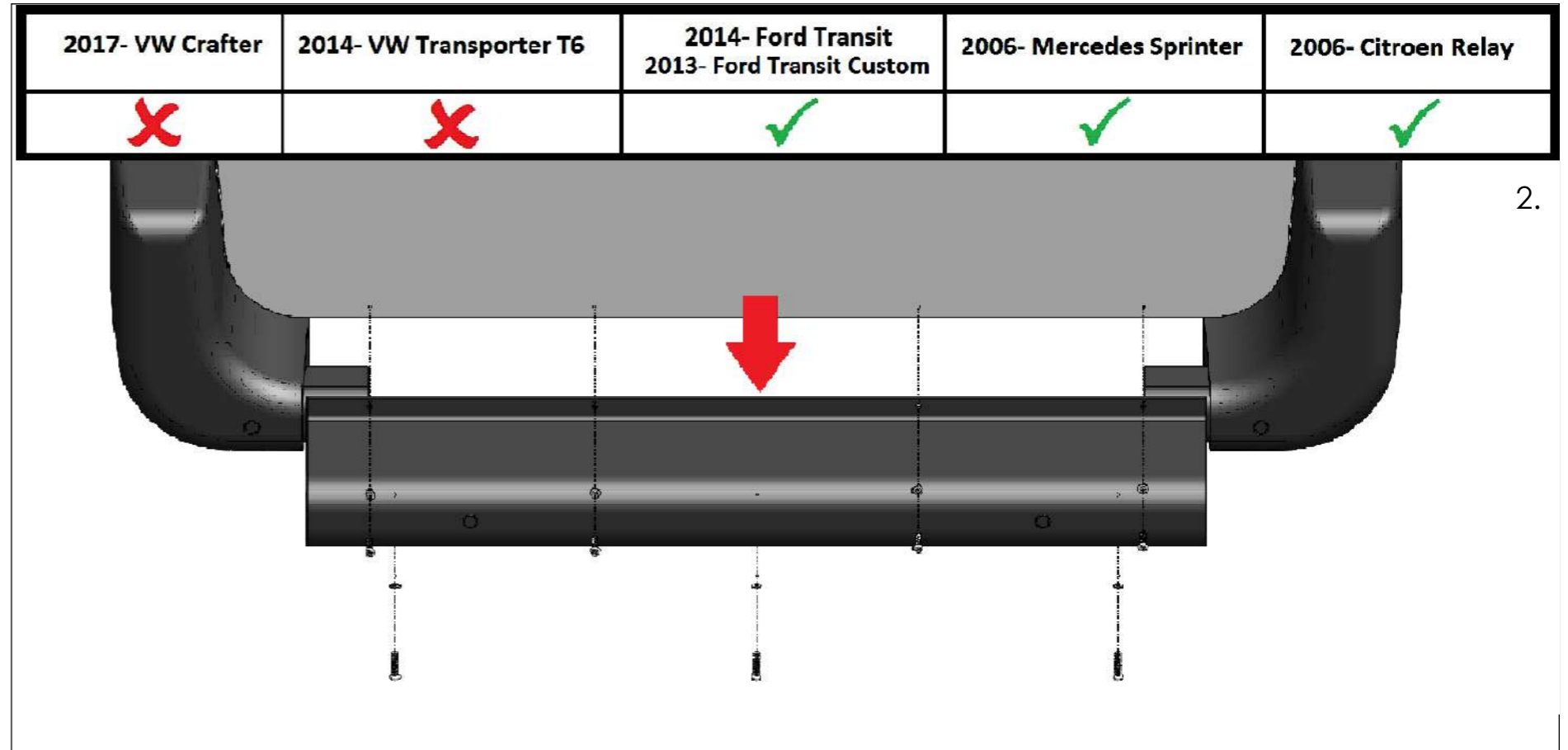
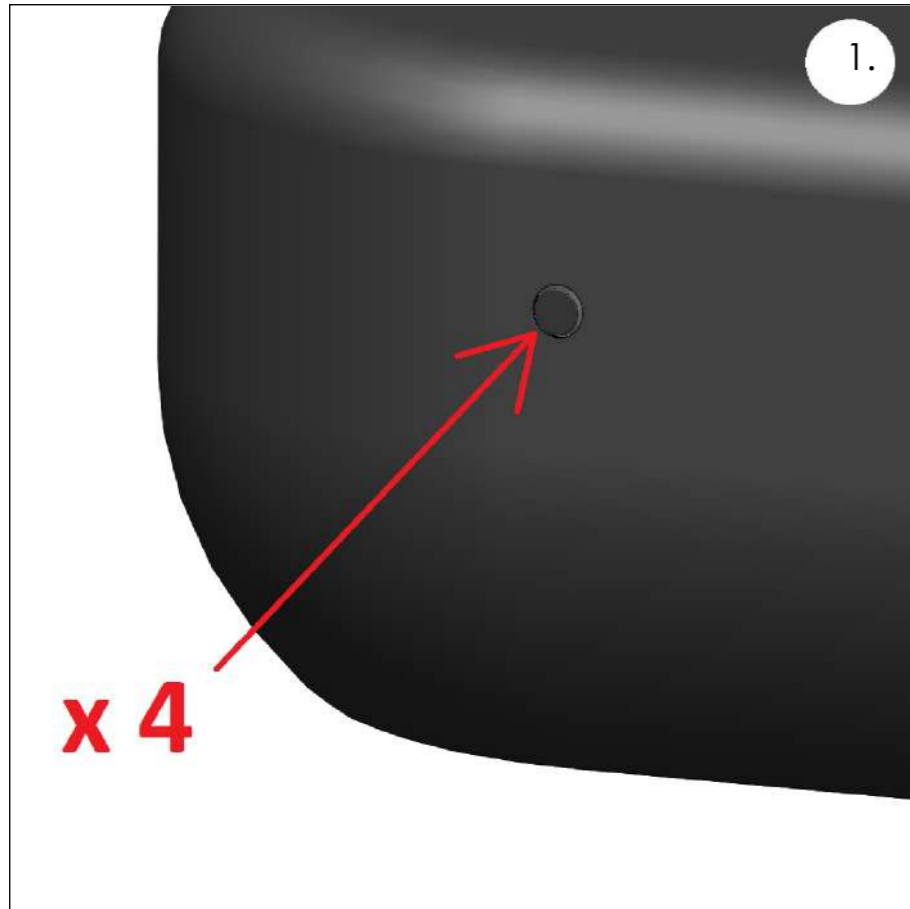

IT: Fare attenzione a non smontare gli adattatori dal gradino durante l'installazione dei sensori.

PL: Nie należy wyjmować adapterów ze stopnia, podczas montażu czujników.

SW: Iakttag försiktighet när sensorerna monteras så att inte adapterna skjuts ur steget.





2017- VW Crafter	2014- VW Transporter T6	2014- Ford Transit 2013- Ford Transit Custom	2006- Mercedes Sprinter	2006- Citroen Relay 6.
 PS366 	 PS366 	 PS366 	 PS366 	 PS366 