

KR28 KammRoller

Instructions

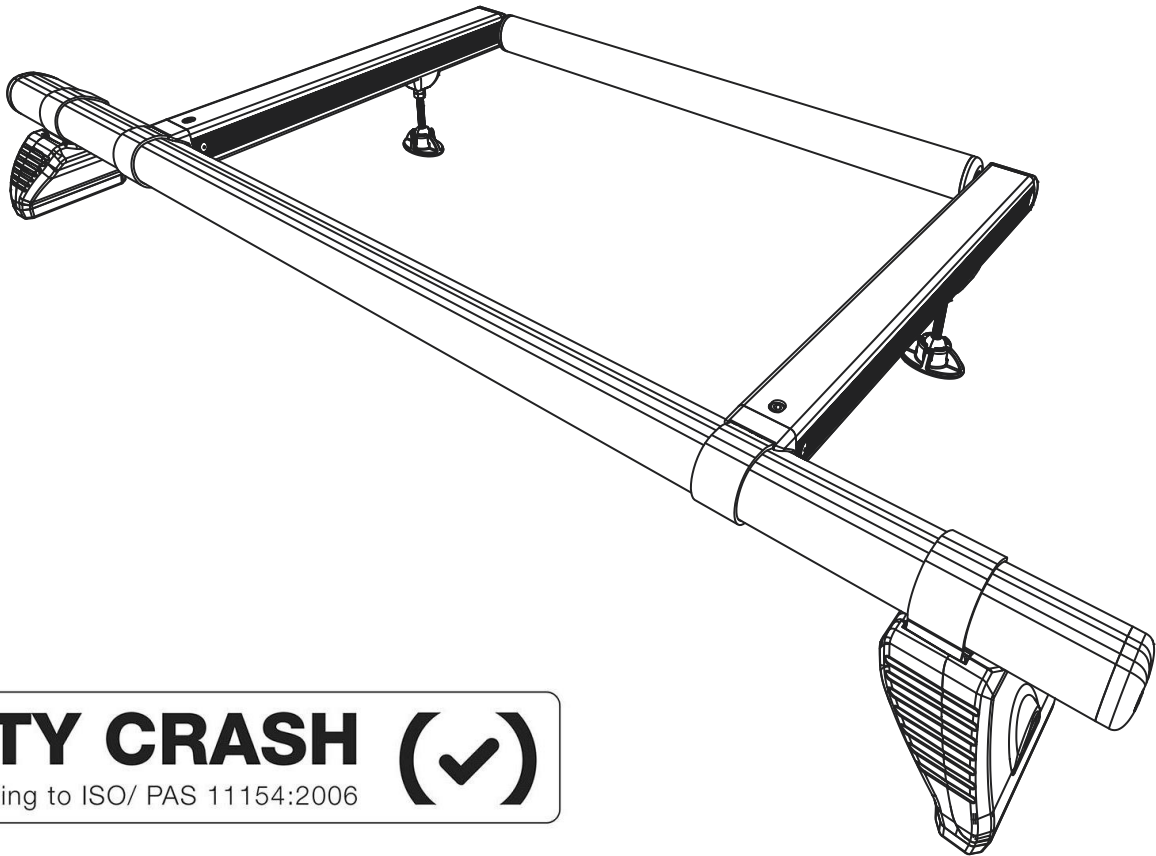

CITY CRASH (✓)

According to ISO/ PAS 11154:2006

Max
50kg/110lbs

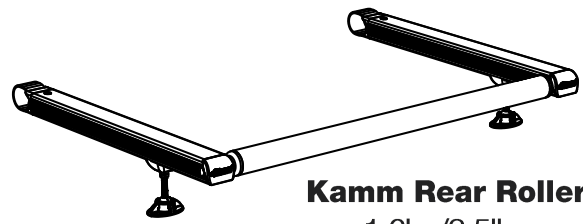
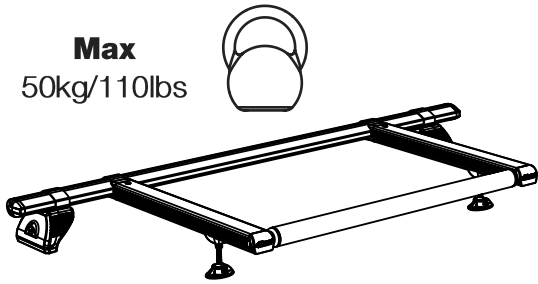

Kamm Rear Roller
1.6kg/3.5lbs

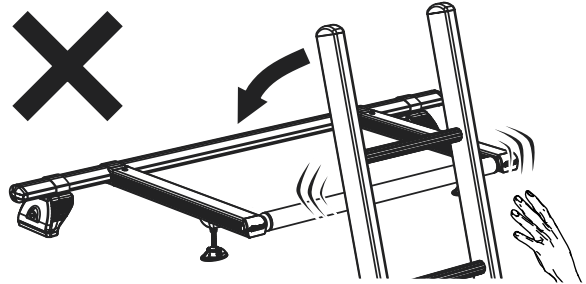
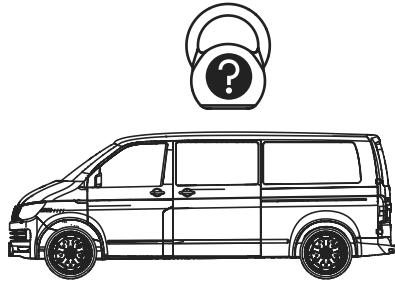

Kamm Rear Roller

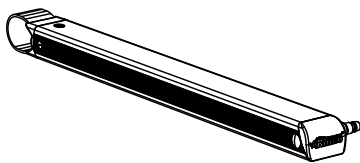

SA410 x 1

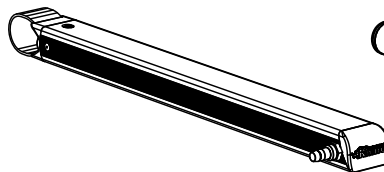

SA411 x 1

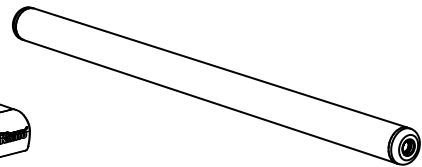

SA400 x 1

Fitting Kit

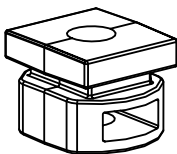

PS201 x 2

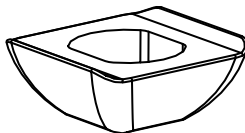

PS202 x 2

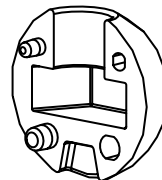

PS203 x 4

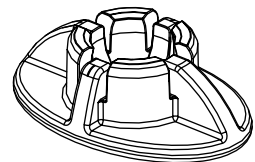

PS204 x 2

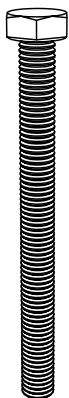

FS109
(M8 x 90) x 2

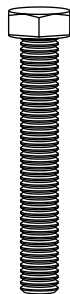

FS105
(M8 x 55) x 2

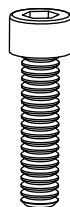

FS103
(M6 x 25) x 2

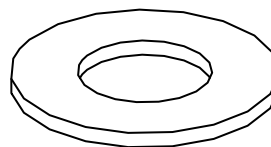

FW021 (M8) x 2

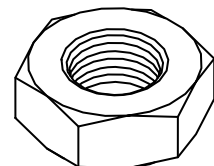

FN039 (M8) x 6

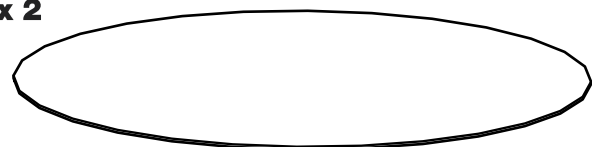

LA074 x 2

1.

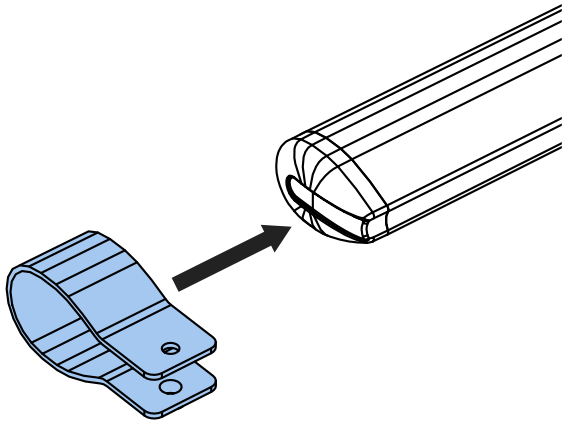

2.

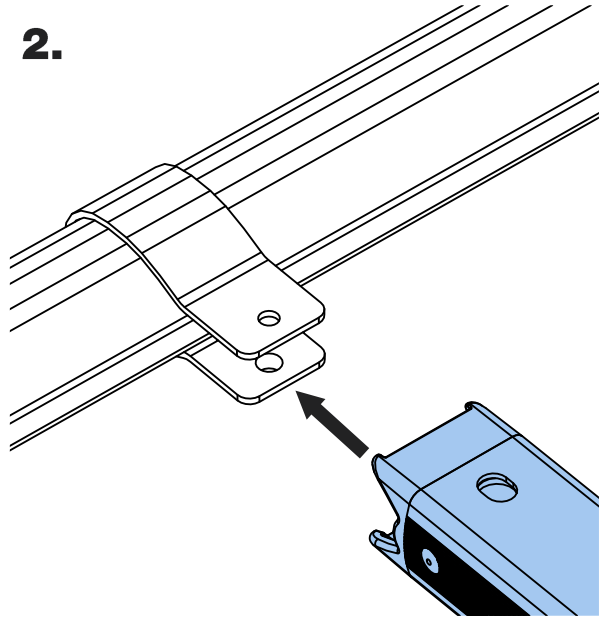

3.

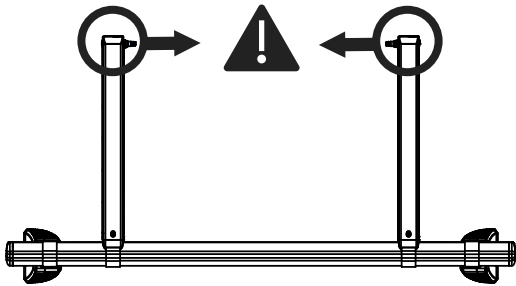

4.

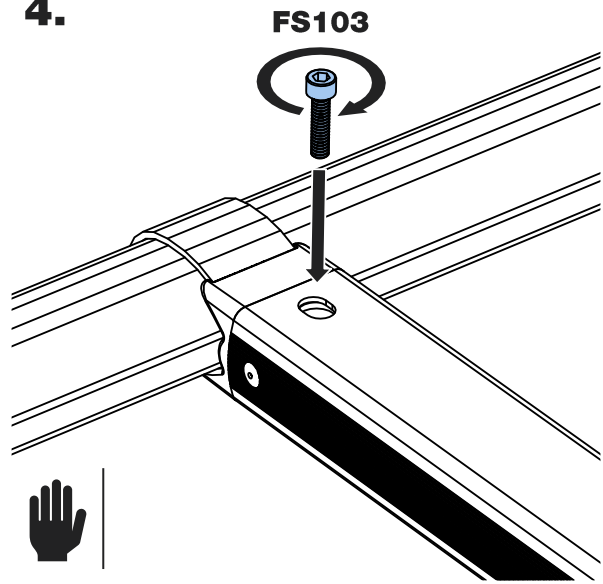

5.

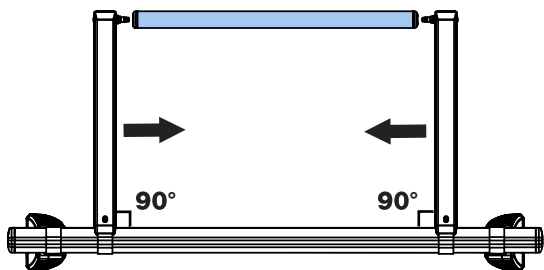

6.

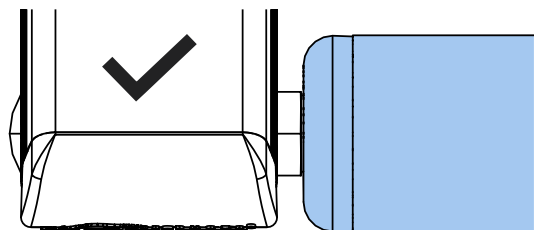
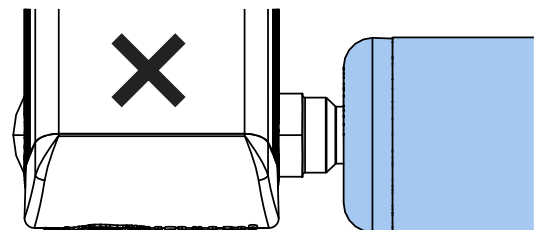

7.

48-75mm = FS105
78-105mm = FS109

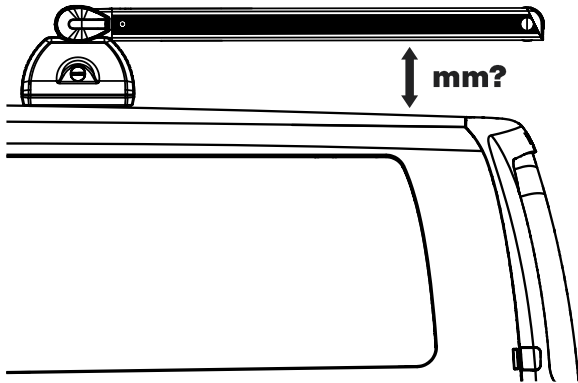

8.

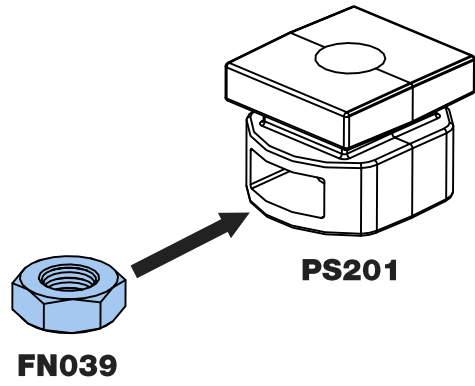

9.

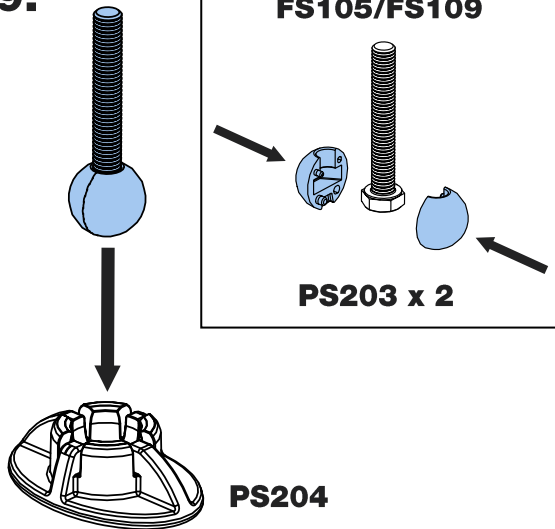

10.

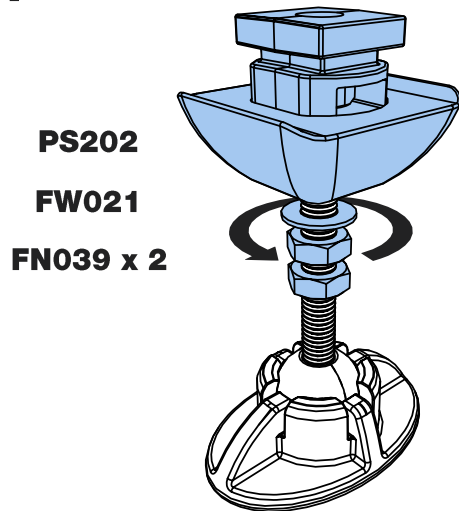

11.

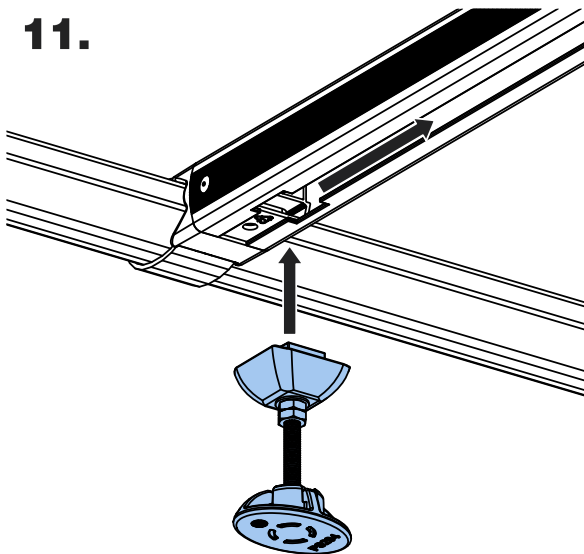

12.

